

SEGA
GENESIS™

FIRE SHARK™

INSTRUCTION
MANUAL

DREAMWORKS

6103



INSTRUCTION MANUAL



FIRE SHARK PROGRAM ©1990 TOAPLAN Co., Ltd.

©1990 Toy Soldiers, Inc. All Rights Reserved.

SEGA™ and GENESIS™ are trademarks of
Sega Enterprises Ltd.

DREAMWORKS is a trademark of Toy Soldiers, Inc.

FIRE SHARK and TOAPLAN CO., LTD. are trademarks of
TOAPLAN CO., Ltd.

DreamWorks, a division of Toy Soldiers, Inc., 10201 Wayzata
Blvd., Minnetonka, MN 55343.

Licensed by Sega Enterprises Ltd. for play on the
SEGA™ GENESIS™ System.

CONTENTS

Loading Instructions/Starting Up.....	2
Fire Shark™, The Game.....	3
Object/Getting Started.....	4
Taking Control.....	5
Mission Stages.....	6
Air-to-Air/Air-to-Ground Weapons.....	9
Know Your Enemies.....	11
Helpful Hints.....	14

INSTRUCTION MANUAL

Loading Instructions/Starting Up:

- 1) Make sure the power switch is OFF.
- 2) Insert the game cartridge in the Genesis System (shown below) as described in your GENESIS SYSTEM manual.
- 3) Turn the power switch ON. If nothing appears on the screen, recheck insertion.

IMPORTANT: Always make sure that the system is turned OFF when inserting or removing your Genesis Cartridge.

For 1 Player: Press Start Button on Genesis Control Pad 1.

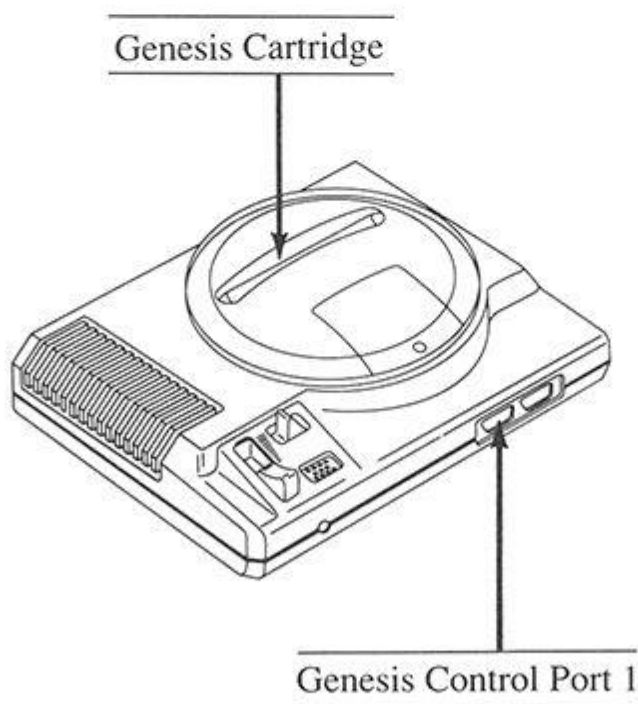

FIRE SHARK™

Governments around the world watch in dread as enemy forces amass on a small South Pacific island. Their numbers grow with each passing day, yet no violent actions are taken. As weeks and months pass, Earth's peace-keeping nations begin to relax their guard. Then Command Central receives this message from a team deep in the field.

REPORT: Enemy forces mobilizing. Objective unknown. Information unreliable. All attempts at intelligence retrieval have failed. Will continue to monitor...

With only this as a warning, the feared strike begins. On land. On water. In the air. The invasion force attacks with unmerciful precision. Communication lines are cut. Army, Air Force, Naval and Marine bases are crushed. All seems lost. The people gather to surrender...when from out of the smokey haze of battle, a single biplane emerges.

The old plane seems to fade away, then grow stronger; more distinct. On its sides, a gleaming "FIRE SHARK" stares straight ahead, a dire apparition with frightening hypnotic power. "Who is he? Where did he come from? What kind of plane is that?" The battered soldiers watched in awed amazement as the biplane flies straight into the jaws of the enemy.

Inside the biplane, a phantom aviator prepares for battle. He is a time-traveler, a flying ace who has gone renegade and flown to the ends of time and back. His mission...self chosen...is to face the impossible and win. Anywhere Earth is threatened he will do battle...to defend the planet that has been his home in another time and place.

He has plundered the technologies of the ages to outfit his plane for war. A quick weapons check shows wing-mounted cannons and blockbuster bombs armed and ready. Other weapons are available...if he can find them. With unerring precision and frightening power, the aviator begins his assault.

He hits the enemy full force. Planes, ships, tanks, bunkers — no enemy is safe from this strange specter's attack!

OBJECT

You are "FIRE SHARK!" In your control is the awesome power that safeguards the destiny of an entire planet. Defeat the enemy forces and take your place of honor in history. But fail...and the hope of millions will fade with you.

You begin the game with up to four lives. The game ends when you have lost your last life. You gain an additional life at 70,000 points and thereafter with every 200,000 points; 270,000, 470,000, etc.

When the game ends you have the option of beginning a new game or selecting CONTINUE to play again at the start of the last stage you played.



GETTING STARTED

Game Start:

Starts FIRE SHARK from the very beginning.

Option:

Using OPTION allows you to change and examine various features of the game.

GAME LEVEL: Lets you adjust the game difficulty from EASY, NORMAL and HARD.

PLAYER: Allows you to select the number of lives per game, from 1–4.

SOUND TEST: Allows you to sample the music and sound effects of FIRE SHARK, 01–40.

RAPID: Rapid fire On or OFF.

EXIT: Returns you to the title screen.

TAKING CONTROL

Fire Shark is a one player game. Make sure your control pad is plugged into the Control Port 1 on your Genesis system.

Genesis Control Pad:

Directional Button
(D-Button)

Start Button

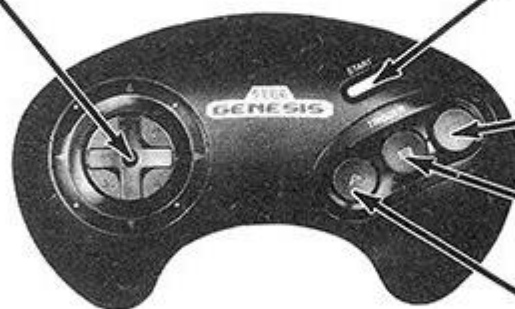

Button C

Button B

Button A

D Button:

Moves Fire Shark UP, LEFT, RIGHT, DOWN and ALL DIAGONALS.

Start Button:

Starts Game. Pauses /Restarts game during play.

A Button:

To fire weapons.

B Button:

To fire BOMBS. Distance that the bombs are fired depends on how long the B Button is held.

C Button: Same functions as A Button.



MISSION STAGES

Fire Shark has ten stages. Here are...briefly...what you must accomplish in each stage.

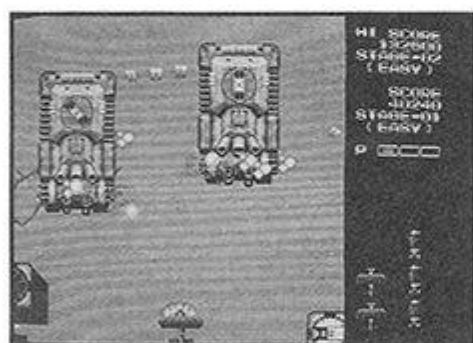

STAGE 1:

Destroy the enemy's two heavily-armored KIMI-B super tanks. Armed with three standard and one rotating cannon.

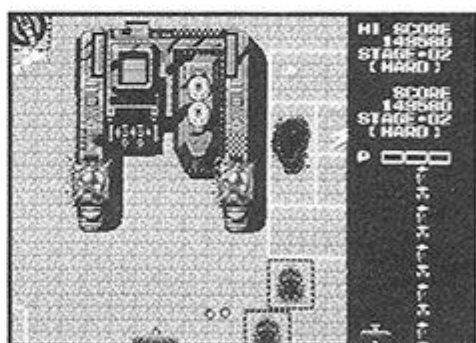

STAGE 2:

Take out the mobile command F-1 Super Tank. It's heavily armed...and dangerous. It can attack you from six directions.

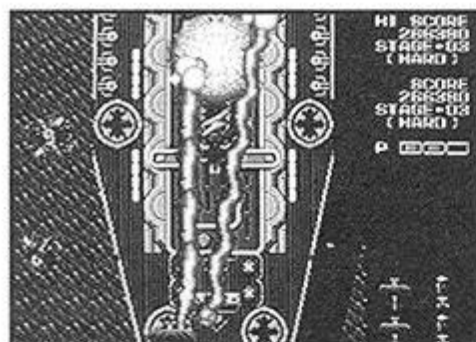

STAGE 3:

Sink the enemy flag ship L-TOMPSON. Watch out for its ten cannons!

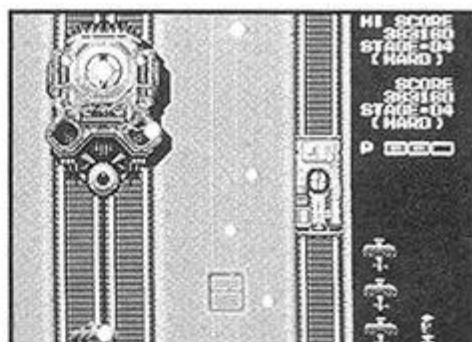

STAGE 4:

Attack the rail line and destroy the enemy armored THUNDER RABBIT rail tank. Its cannon can swivel to any direction!

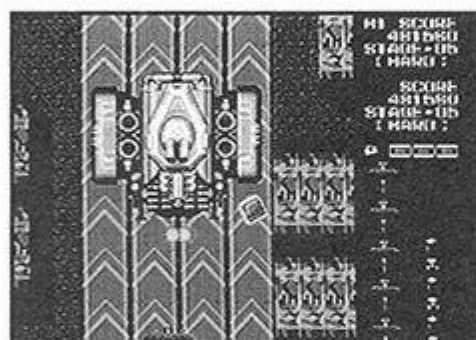

STAGE 5:

Wipe out regrouping forces and shoot it out with the enemies most powerful armored vehicle yet, the 1020 TERROR!



STAGE 6:

This round is an air-to-air, air-to-ground desert brawl against armored troop carriers and the nine-gun super bomber, the 227 ROOSTER.



STAGE 7:

An urban air raid against the UK MAD DOG, a multi-gunned bomber with some nasty tricks up its sleeve.

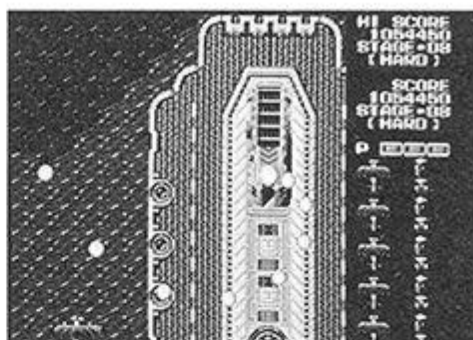

STAGE 8:

Back over the water for a battle against super submarines and a heavily armed, monster sized tanker, the J CONNIVER. It has 46 cannons!

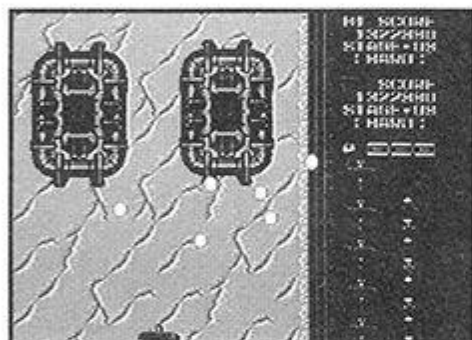

STAGE 9:

Wipe out the large, armored hovercraft, the TSUNAMI. Fires bombs, cannons and scatter shot.



STAGE 10:

The final conflict...take on the enemy's strongest guard forces as you attempt to destroy the evil empire's armored assault fortress, the YUKIGEN 61. This battle decides the fate of the world. Make it count!

AIR-TO-AIR/ AIR-TO-GROUND WEAPONS

You begin Fire Shark with a tri-shot cannon and three bombs. In the course of playing you will have the opportunity to pick up other weapons and power-up items to make you stronger!



Speed Up

This item increases your flying speed and mobility. You can increase your speed a maximum of three times per life.



Power Up

Upgrades your weapon each time you collect three. There are three weapon upgrades: Wide Shot, Shark Beam and Super Fire.



One Up

Increases your number of lives by one.



Two Up

Increases your number of lives by two.



Bonus

Adds 100 points to your score. You also get special bonus points at the end of the round.

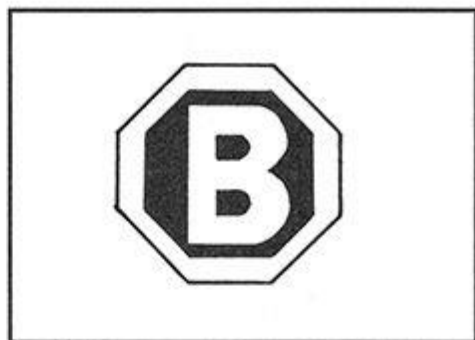

Bomb

Increases your number of bombs by one. You can hold up to ten bombs.

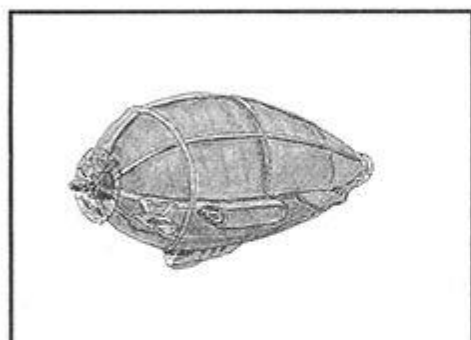

General Porter

A blimp that provides various items when you destroy it. Be careful, as it will attack you.

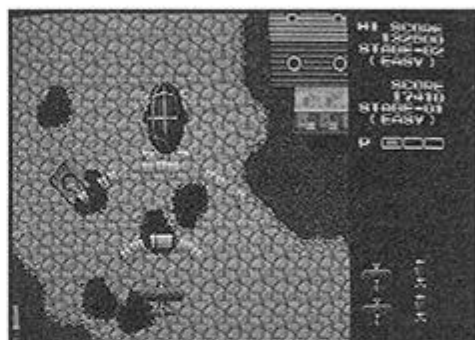

Wide Shot

The standard weapon of your biplane. As you get power ups, the number of shots you fire per blast will increase, up to 16. But the power of each individual bullet is rather weak, so you will have to fire at some enemies repeatedly to take them out.

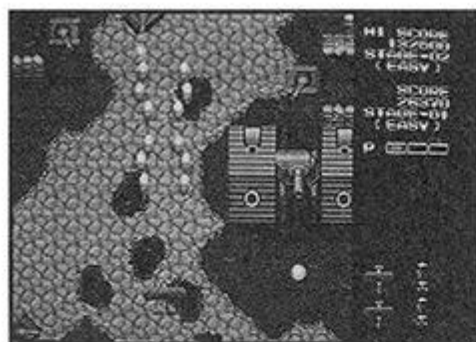

Shark Beam

A green laser for forward attacks. It fires a spiral pattern for greater effect and ground coverage.



Super Fire

The strongest weapon of all, a fire-beam that fires as long as you press Button A. As you collect power-ups the number of fire-beams you shoot increases to four, for awesome, devastating power!

KNOW YOUR ENEMIES

In *Fire Shark* every vehicle you see in the air, on land or the sea...is your enemy. Some fire on you and some don't. But do not take any chances! Here is a partial list of what you can expect to do battle against.

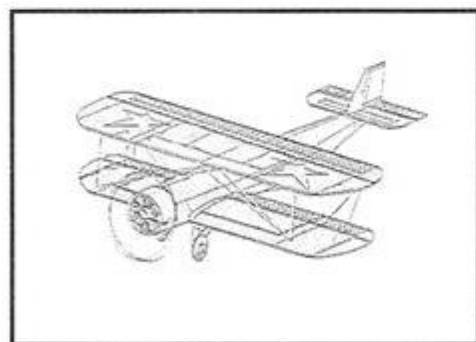

UMI Fighter

Small but fast...and accurate.



HIBARI Tank

They appear in groups.

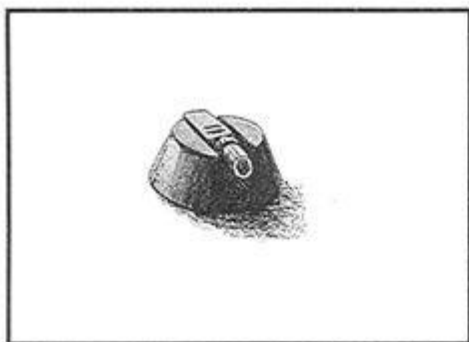

SK Base Cannon

Red Anti-aircraft cannon.
Shoot them for bonus items.

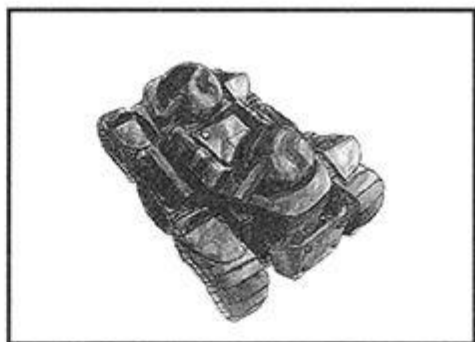

4A Cannon Cruiser

Has two cannons, moves in
four directions!

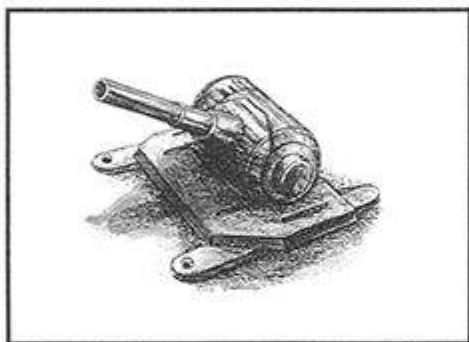

UAS Cannon

Unmanned roof cannon. Fires
forward. Easy to dodge.

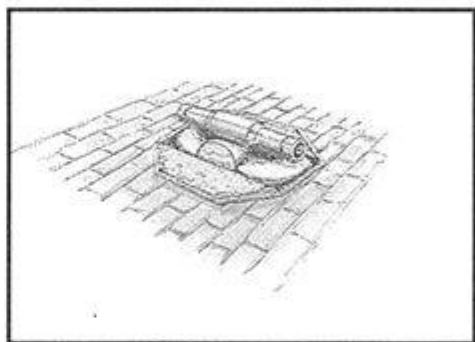

MT Bunker Cannon

Rises from bunkers to fire
with devastating accuracy.
There are vertical, horizontal
and diagonal MT cannons.
Watch out!

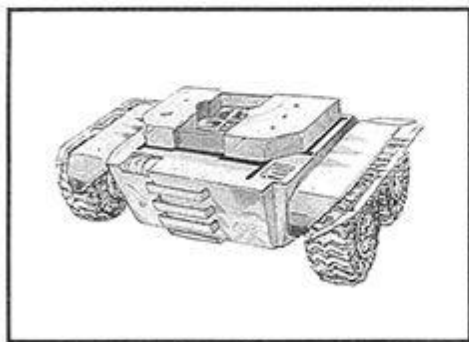

Adon 603 Cruiser

Tracks and fires in all
directions; including
diagonals.

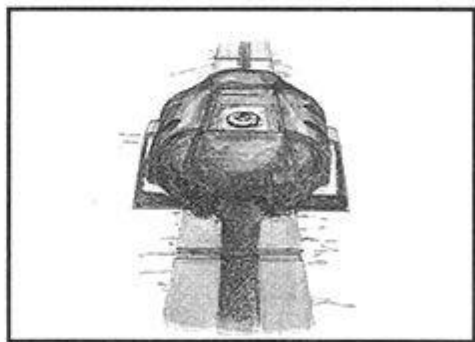

EP Railed Vehicle

Rail-bound, lightly armored
vehicle as powerful as a
mid-sized tank.

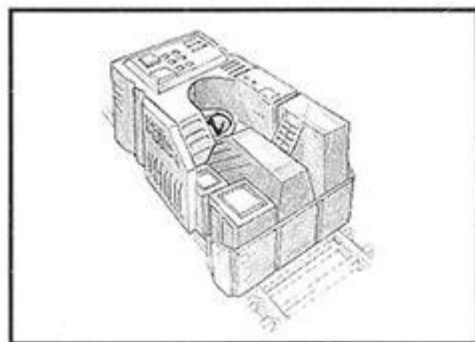

Loco Tank

Heavily armored, rail-bound vehicle with four cannons. This one is tough!

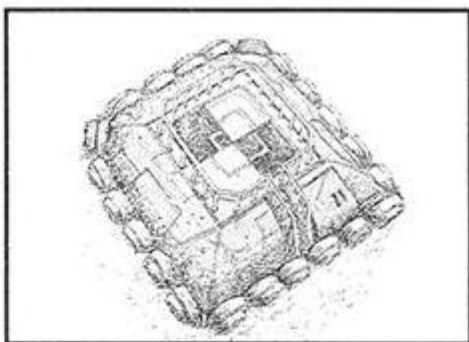

99A Interceptor

Moves up, down, left and right. Fires up to nine cannon blasts at once.

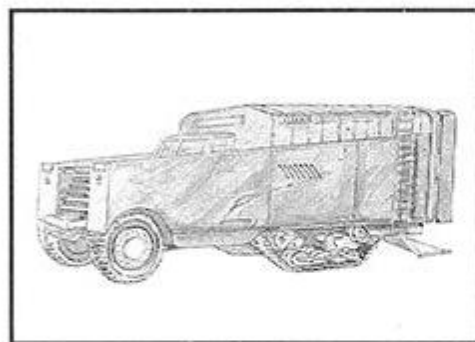

YP 33 Truck Carrier

Non-attacking, but carries tanks.

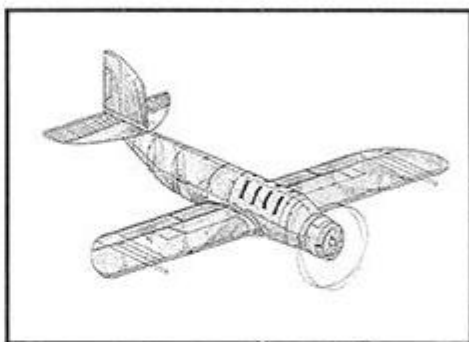

1KK Mid-Size Fighter

Flies in a zig-zag pattern.

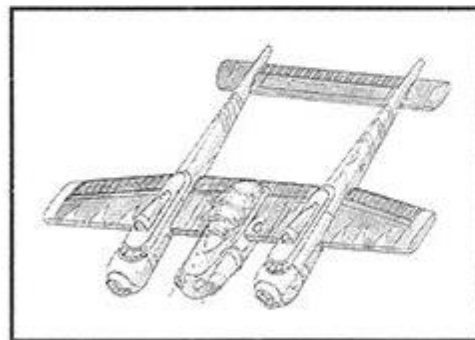

Heavy Bomber

High speed flier that shoots two cannons from the front and four each from the left and right cannons.

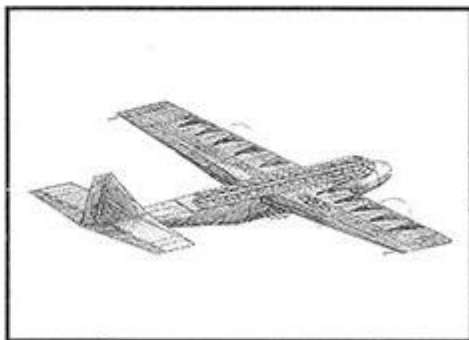

Gatling Fighter

A flying fortress with 18 guns on top...all aimed at you!

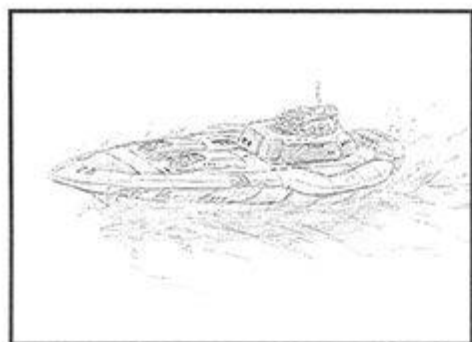

Interceptor Fleet Craft

Forward-moving ship with eight cannons mounted center and two each on the left and right sides.

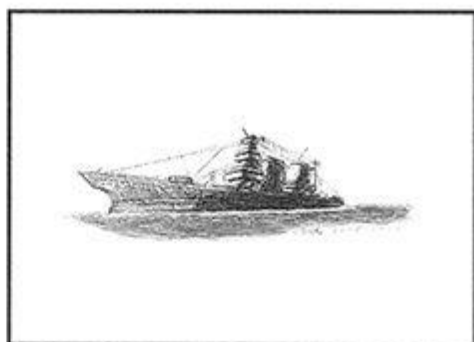

Mid Sized Cruiser

Carries seven anti-aircraft cannons and a hidden cannon. Has a wide range of attacking power.



No. 8 Submarine

Attacks repeatedly and in strength.

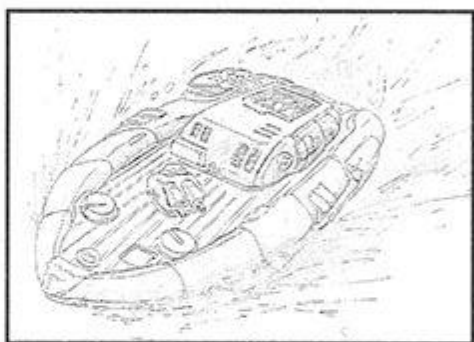

Cargo Ship

Special unit carrier. Destroy it to receive various items. Be careful — it will attack you.

HELPFUL HINTS

The enemy forces always attack in patterns. Learn them and the order they come in to get farther into the game.

Hang on to the most powerful weapons as long as you can, even if it means avoiding other weapons you really don't want.

Save bombs for your biggest enemies.

Rapid fire makes it easier to get farther into the game...faster!

DREAMWORKS LIMITED WARRANTY

DreamWorks warrants to the original purchaser of this DreamWorks product that this cartridge is free from defects in materials and workmanship for a period of ninety (90) days from the date of purchase. This DreamWorks product is sold "as is", without expressed or implied warranty of any kind, and DreamWorks is not liable for any losses or damages of any kind resulting from the use of this product. DreamWorks agrees for a period of ninety (90) days to either repair or replace, at its option, free of charge, this DreamWorks product when returned to a DreamWorks authorized dealer, with dated proof of purchase.

This warranty shall not be applicable and shall be void if the defect in this DreamWorks product has arisen through abuse, unreasonable use, mistreatment or neglect. THIS WARRANTY IS IN LIEU OF ALL OTHER WARRANTIES AND NO OTHER REPRESENTATIONS OR CLAIMS OF ANY NATURE SHALL BE BINDING ON OR OBLIGATE DREAMWORKS. ANY IMPLIED WARRANTIES APPLICABLE TO THIS SOFTWARE PRODUCT, INCLUDING WARRANTIES OF MERCHANTABILITY AND FITNESS FOR A PARTICULAR PURPOSE ARE LIMITED TO THE NINETY (90) DAY PERIOD DESCRIBED ABOVE. IN NO EVENT WILL DREAMWORKS BE LIABLE FOR ANY SPECIAL, INCIDENTAL, OR CONSEQUENTIAL DAMAGES RESULTING FROM POSSESSION, USE, OR MALFUNCTION OF THIS DREAMWORKS PRODUCT.

Some states do not allow limitations as to how long an implied warranty lasts and/or exclusions or limitations of incidental or consequential damages, so the above limitations and/or exclusions of liability may not apply to you. This warranty gives you specific rights, and you may also have other rights which vary from state to state.

DreamWorks, A division of Toy Soldiers, Inc.
10201 Wayzata Blvd., Suite 150
Minnetonka, MN 55343
Tel.: (612) 591-0609

FIRE SHARK PROGRAM ©1990  **TOAPLAN Co.,Ltd.**

©1990 Toy Soldiers, Inc. All Rights Reserved.
SEGA™ and GENESIS™ are trademarks of Sega Enterprises Ltd.
DREAMWORKS is a trademark of Toy Soldiers, Inc.

**FIRE SHARK and TOAPLAN CO., LTD. are trademarks
of TOAPLAN CO., Ltd.**

**This game is licensed by Sega Enterprises Ltd. for play on the
SEGA™ GENESIS™ System.**