

4WHEEL

THUNDER™



SEGA®

MIDWAY

EVERYONE
TM
E
CONTENT RATED BY
ESRB

T-9708N

WARNINGS Read Before Using Your Sega Dreamcast Video Game System

CAUTION

Anyone who uses the Sega Dreamcast should read the operating manual for the software and console before operating them. A responsible adult should read these manuals together with any minors who will use the Sega Dreamcast before the minor uses it.

HEALTH AND EPILEPSY WARNING

Some small number of people are susceptible to epileptic seizures or loss of consciousness when exposed to certain flashing lights or light patterns that they encounter in everyday life, such as those in certain television images or video games. These seizures or loss of consciousness may occur even if the person has never had an epileptic seizure.

If you or anyone in your family has ever had symptoms related to epilepsy when exposed to flashing lights, consult your doctor prior to using Sega Dreamcast.

In all cases, parents should monitor the use of video games by their children. If any player experiences dizziness, blurred vision, eye or muscle twitches, loss of consciousness, disorientation, any involuntary movement or convulsion, **IMMEDIATELY DISCONTINUE USE AND CONSULT YOUR DOCTOR BEFORE RESUMING PLAY.**

To reduce the possibility of such symptoms, the operator must follow these safety precautions at all times when using Sega Dreamcast:

- Sit a minimum of 6.5 feet away from the television screen. This should be as far as the length of the controller cable.
- Do not play if you are tired or have not had much sleep.
- Make sure that the room in which you are playing has all the lights on and is well lit.
- Stop playing video games for at least ten to twenty minutes per hour. This will rest your eyes, neck, arms and fingers so that you can continue comfortably playing the game in the future.

OPERATING PRECAUTIONS

To prevent personal injury, property damage or malfunction:

- Before removing disc, be sure it has stopped spinning.
- The Sega Dreamcast GD-ROM disc is intended for use exclusively on the Sega Dreamcast video game system. Do not use this disc in anything other than a Sega Dreamcast console, especially not in a CD player.
- Do not allow fingerprints or dirt on either side of the disc.
- Avoid bending the disc. Do not touch, smudge or scratch its surface.
- Do not modify or enlarge the center hole of the disc or use a disc that is cracked, modified or repaired with adhesive tape.
- Do not write on or apply anything to either side of the disc.
- Store the disc in its original case and do not expose it to high temperature and humidity.
- Do not leave the disc in direct sunlight or near a radiator or other source of heat.
- Use lens cleaner and a soft dry cloth to clean disc, wiping gently from the center to the edge. Never use chemicals such as benzene and paint thinner to clean disc.

PROJECTION TELEVISION WARNING

Still pictures or images may cause permanent picture tube damage or mark the phosphor of the CRT. Avoid repeated or extended use of video games on large-screen projection televisions.

SEGA DREAMCAST VIDEO GAME USE

This GD-ROM can only be used with the Sega Dreamcast video game system. Do not attempt to play this GD-ROM on any other CD player; doing so may damage the headphones and/or speakers. This game is licensed for home play on the Sega Dreamcast video game system only. Unauthorized copying, reproduction, rental, public performance of this game is a violation of applicable laws. The characters and events portrayed in this game are purely fictional. Any similarity to other persons, living or dead, is purely coincidental.

TABLE OF CONTENTS

GETTING STARTED	3-4
MAIN MENU	5
OPTIONS MENU	6-8
4 WHEEL BASICS	9
DEFAULT CONTROLS	10
PLAYING THE GAME	11-13
PRACTICE MODE	14
ARCADE MODE	15
CHAMPIONSHIP MODE	16-17
JACKPOT!	18
TWO PLAYER GAMES	19 -23
4 WHEEL HINTS	24
CREDITS	27-29
WARRANTY	30



GETTING STARTED

Before you begin to play 4 Wheel Thunder, pay attention to the following information regarding your Sega Dreamcast Hardware Unit.

- Be sure the Power is off on your Sega Dreamcast system.
- Plug in your Sega Dreamcast Controller.
 - *One controller is included with the Sega Dreamcast at the time of purchase. Additional controllers and peripherals are sold separately. For more information on the Sega Dreamcast Controller, see the next page.
- Insert your 4 Wheel Thunder Sega Dreamcast Specific Disc.
- Press the Power Button to activate the Sega Dreamcast.
- Follow on-screen game instructions.

SEGA DREAMCAST HARDWARE UNIT

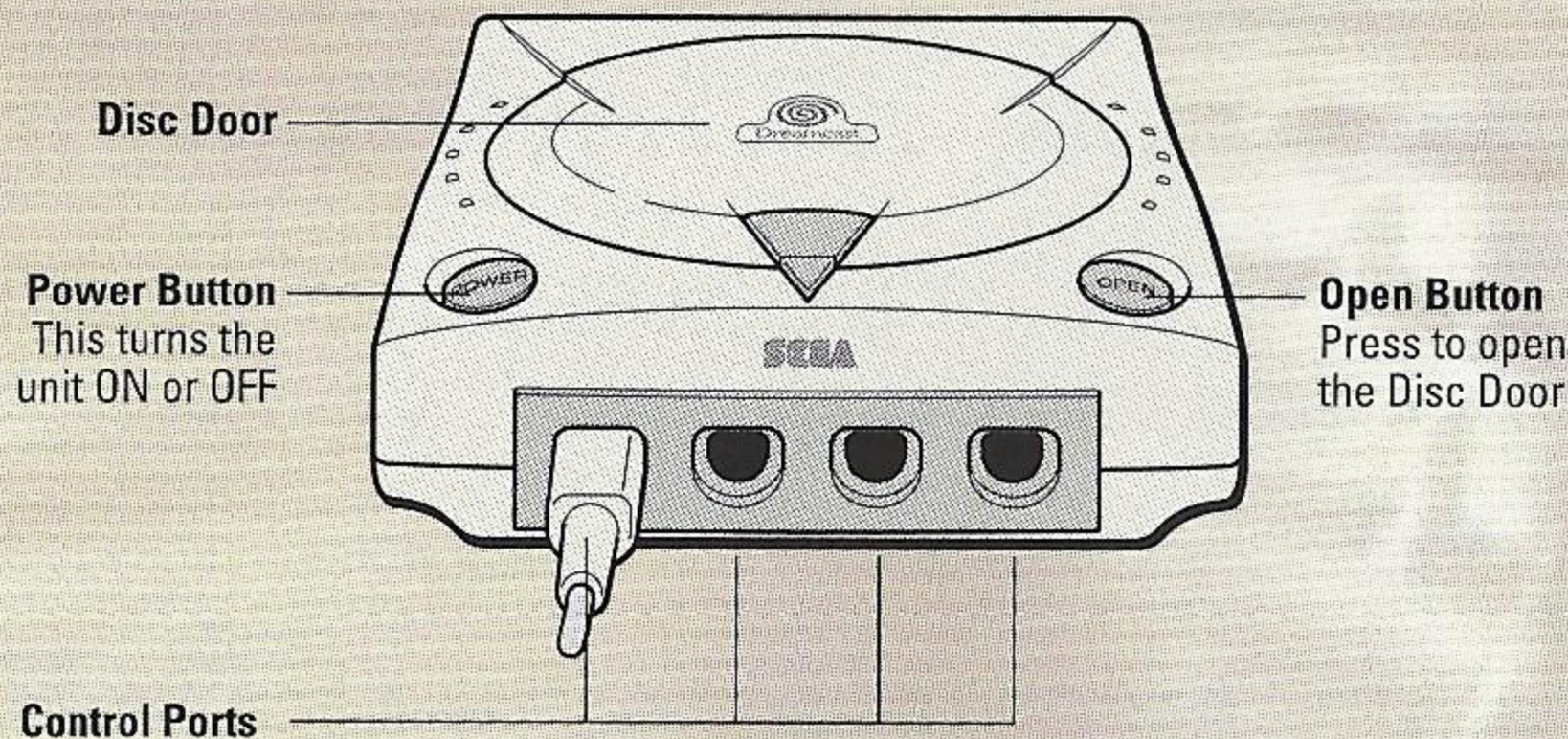

Use these ports to connect the Sega Dreamcast Controller or other peripheral equipment. From left to right are **Control Port A**, **Control Port B**, **Control Port C**, and **Control Port D**. Use each port to connect controllers for players 1 to 4 respectively.

GETTING STARTED

4 Wheel Thunder is a 1 or 2 Player game. Before turning the Sega Dreamcast power ON, connect the controller or other peripheral equipment into the control ports of the Sega Dreamcast. To return to the title screen at any point during game play, simultaneously press and hold the A, B, X, Y and Start Buttons. This will cause the Sega Dreamcast to soft-reset the software and display the title screen.

SEGA DREAMCAST CONTROLLER

Overhead View

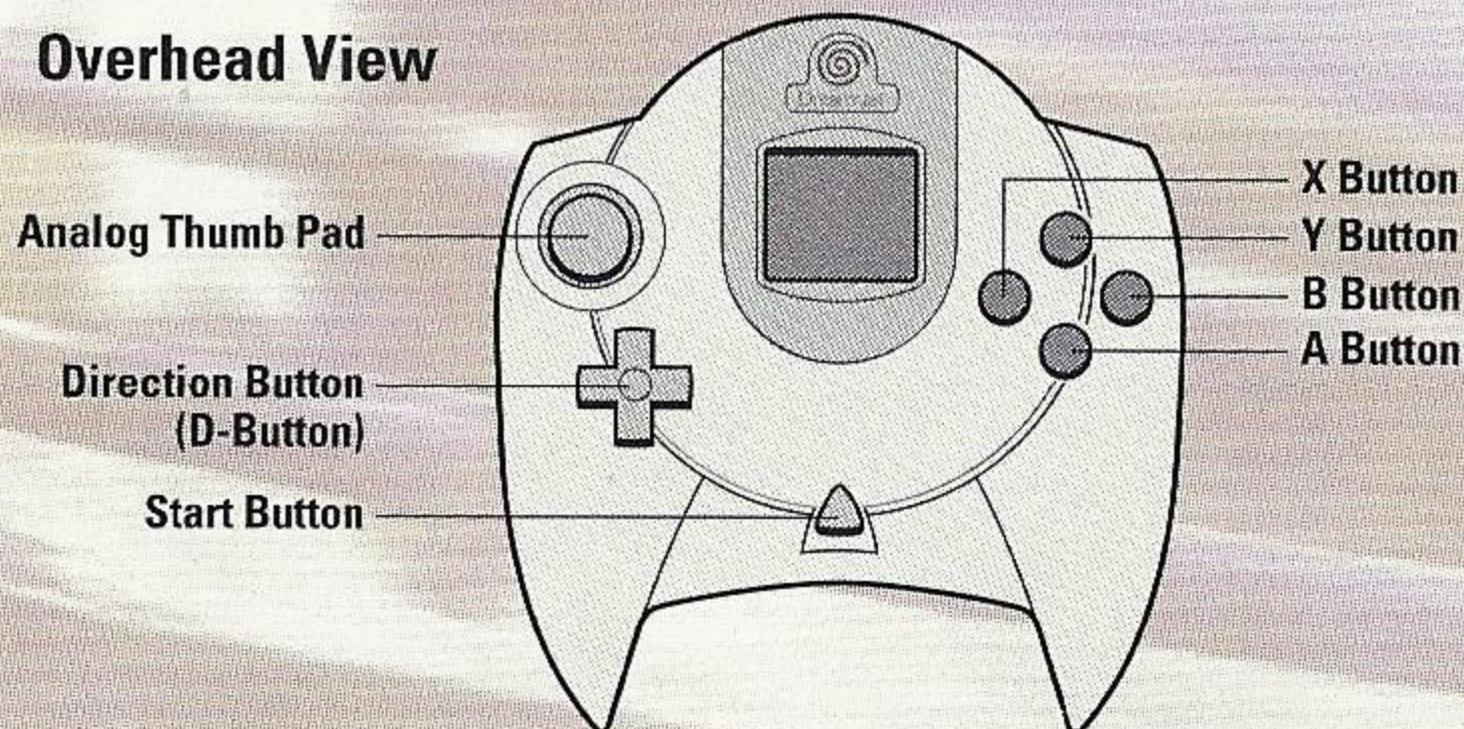

Forward View

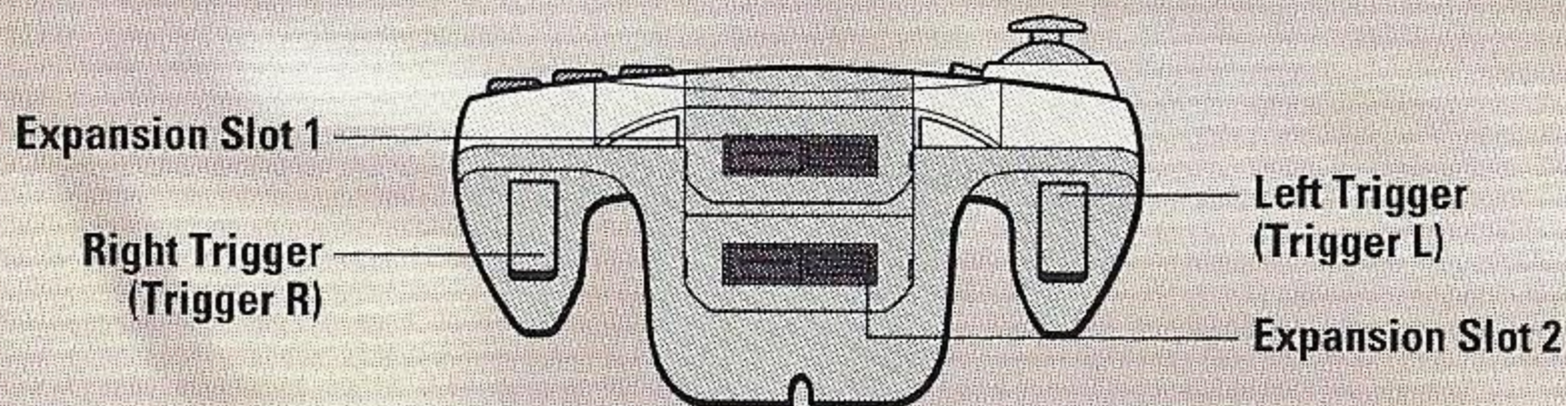

Default controls for 4 Wheel Thunder are listed on Page 10.



MAIN MENU

At the game's Title Screen press the Start Button to access the Main Menu.

The game's Main Menu allows you to play either a 1 or 2-Player game (if two controllers are inserted), adjust the game's Options and view the Hall of Fame (High Scores). Press Up and Down on the Analog Thumb Pad or Direction Button to toggle the menu items. Press the A Button to access the item.

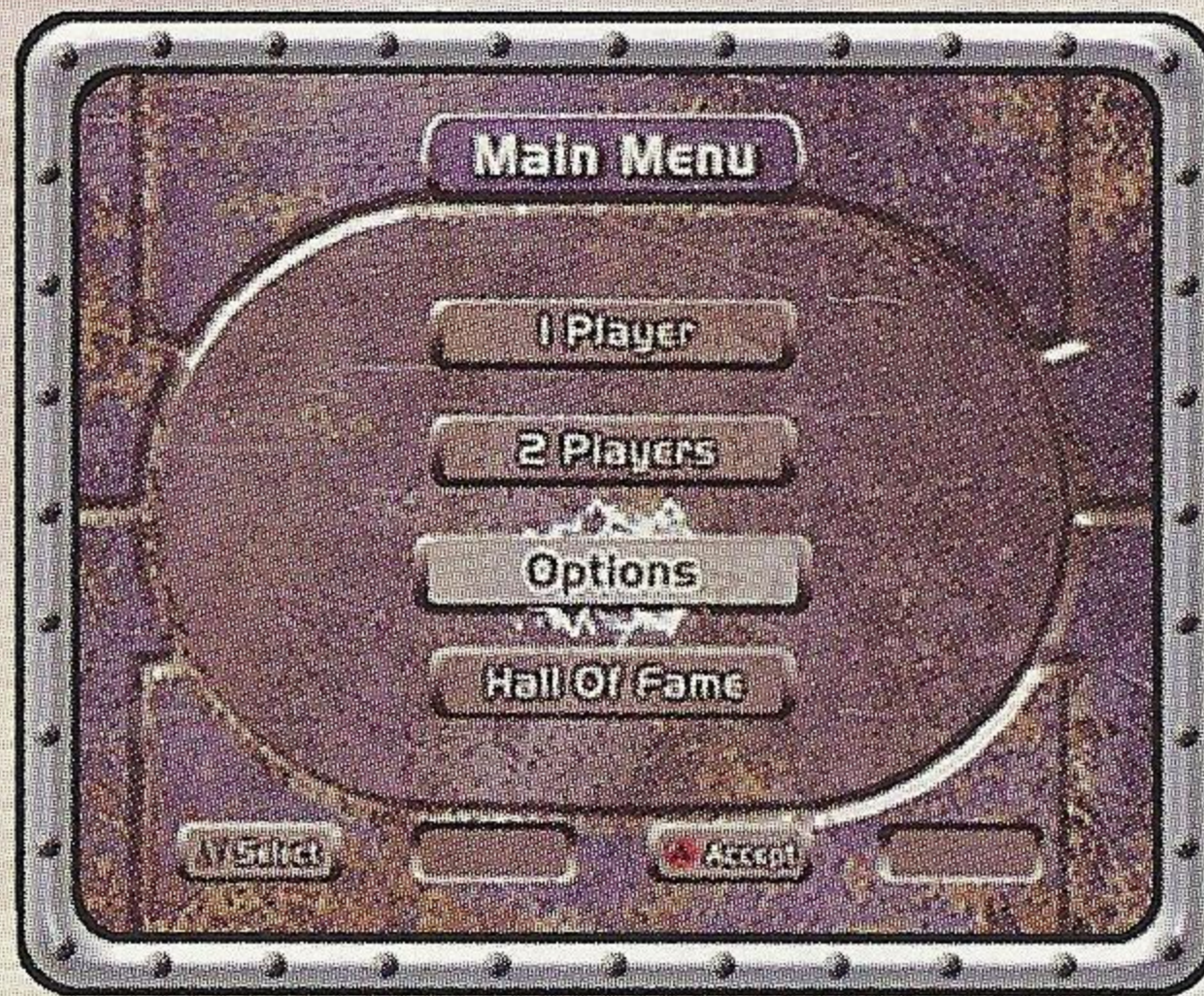

Before we discuss how to play the game, let's check out the Options Menu.

OPTIONS MENU

At the Main Menu, highlight **OPTIONS** and press the **A Button**.

There are three sub-menus to choose from in this menu. The sub-menus are **SOUND**, **CONTROLS** and **LOAD/SAVE**.

SOUND

Options in this sub-menu deal with what else, the sounds of the game. **SOUND VOLUME** controls the volume of the game's sound effects. **MUSIC VOLUME** adjusts the volume of the game's background music. Each of the volume options are numbered 0 (no sound) through 100 (full blast). Each can be adjusted by highlighting the appropriate option and pressing **Left** and **Right** on the **Direction Button** or **Analog Thumb Pad**.

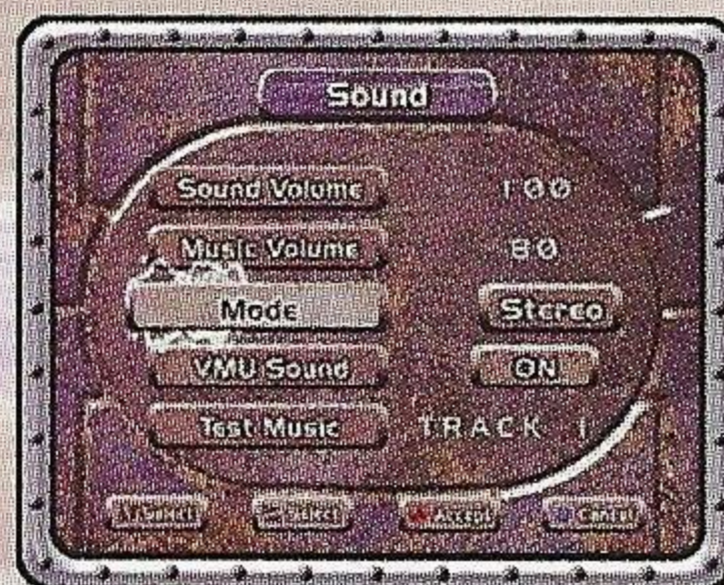

MODE lets you select the overall sound output of the game sounds. **STEREO** is both speakers while **MONO** is one speaker. Once again, press **Left** and **Right** on the **Direction Button** or **Analog Thumb Pad** to cycle between the two.

VMU SOUND will turn the sound **ON** or **OFF** on your **VMU** (if one is connected).

TEST MUSIC allows you to listen to the 13 different music tracks in the game. Press **Left** and **Right** on the **Direction Button** or **Analog Thumb Pad** to select an audio track.

When you are finished making adjustments to the options, press the **A Button** to activate any changes you made and return to the **Options Menu**.



OPTIONS MENU

CONTROLS

The Controls sub-menu allows you to change the configuration of your controller. The list in the center of your screen displays every control in the game. To change the configuration, highlight the action and press the A Button. This will disengage the action and replace it with a question mark (?). Next, press the button that you want to correspond with that action. For example, if you wanted to change the Accelerate action (default is the R Trigger) and make it correspond with the B Button, highlight Accelerate and press the A Button (the R Trigger graphic will be replaced with the question mark). Next, press the B Button to assign that button with the Accelerate action.



SEGA DREAMCAST JUMP PACK™

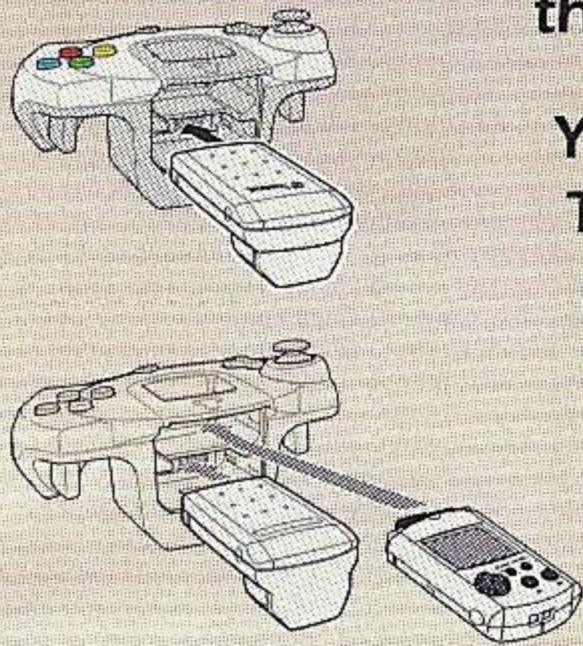

NOTE: To return to the title screen at any point during game play, simultaneously press and hold the A, B, X, Y and Start Buttons. This will cause the Sega Dreamcast to soft-reset the software and display the title screen.

You can assign the Direction Button and Analog Thumb Pad as well. Simply press either in a direction (this will mostly be for steering your vehicle) when the question mark symbol is displayed.

You are also able to switch the Jump Pack (sold separately) ON or OFF. Press Left and Right on the Direction Button or Analog Thumb Pad to switch. When you are finished changing the controls, highlight EXIT and press the A Button.

To reset the Controls to their Default Settings, select "Initialize Settings" and press the A Button.

OPTIONS MENU

LOAD/SAVE

Your Sega Dreamcast system features four Control Ports (A,B,C & D) which allow up to four controllers to be connected. Each Sega Dreamcast controller has two Expansion Slots. These Expansion Slots can hold items like the VMU (shown to the right) and Jump Pack. When playing 4 Wheel Thunder, you will need a VMU with at least 16 Blocks free in order to save game data and 70 Blocks free to save replays.

The Visual Memory Unit (VMU) is a type of memory card, sold separately, that is used to save game files. Game files can be saved and loaded under this portion of the Options Menu. Select LOAD/SAVE and press the A Button.

Using the Direction Button or Analog Thumb Pad, select the Control Port and Expansion Slot that connects to the VMU you wish to use. When you have located the appropriate VMU, press the A Button to save or load the game data. After a confirmation (telling you whether the data was saved/loaded or not), you will return to the Options Menu.

To exit back to the Main Menu from the Options Menu, press the B Button.

WARNING: While saving a game file, never turn OFF the Sega Dreamcast power, remove the memory card or disconnect the controller.

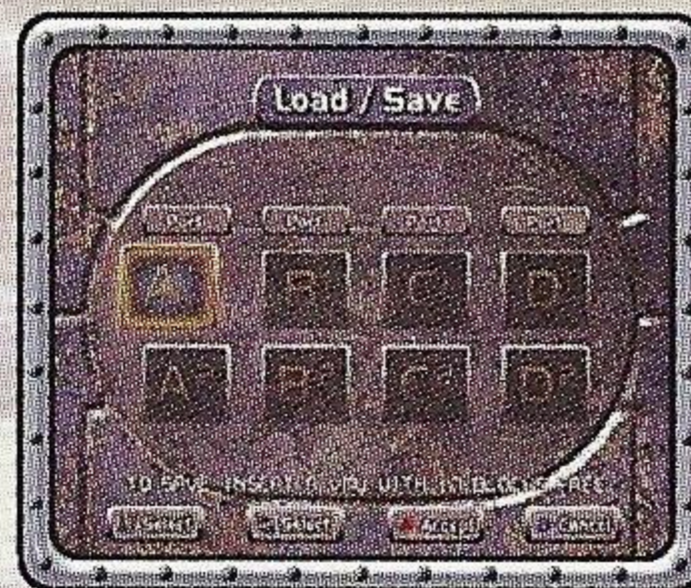
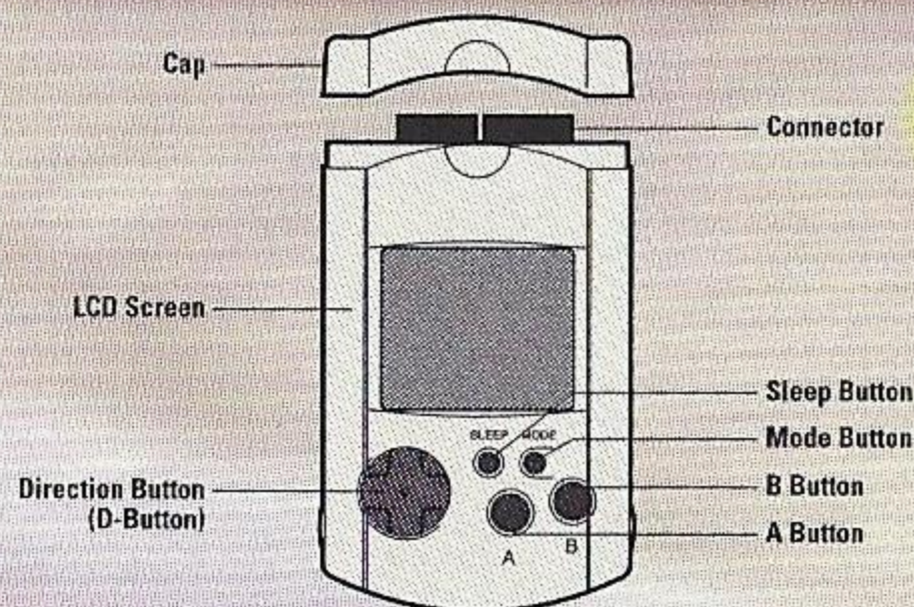

4 WHEEL BASICS



4 Wheel Thunder is a mud-flyin', tire-grabbin' romp through a variety of tracks. It's you against up to 11 opponents in an all-terrain assault on the senses! Choose from 4 different vehicle types (Monster Truck, Buggy, Jeep & Quad) and take on over 24 tracks (if you're good enough to gain access to them)! On your quest to become a winner, collect valuable Boost Icons to give your vehicle extra speed.

TRACK AND VEHICLE SELECTION



To select tracks and vehicles (which are available to you), use the Direction Button or Analog Thumb Pad and press Left or Right to view your choices. Keep in mind that your choices available are only tracks and vehicles you have earned (unlocked) during the game. When selecting a track or a vehicle, you can view it from all angles. Select the



VIEW from the menu (on the right of the track and vehicle selection screens) and press the A Button. When you move the Analog Thumb Pad, you can rotate the 3D object and speed or slow its rotation. Hold the R Trigger to zoom in on the object and get a closer look. To exit back to the previous screen, press the B Button.



When selecting a vehicle, you can choose between an Automatic (no gear-shifting) Transmission or a Manual (gear-shifting) Transmission. Select the transmission you want by highlighting Automatic or Manual and then press the A Button. You can also test a vehicle by highlighting TEST CAR and pressing the A Button. This will take you to a practice track which contains just about every road condition you may encounter.



DEFAULT CONTROLS

Before we teach you how to play the game, we'll show you the controls. Here's the default controls for your Sega Dreamcast controller.

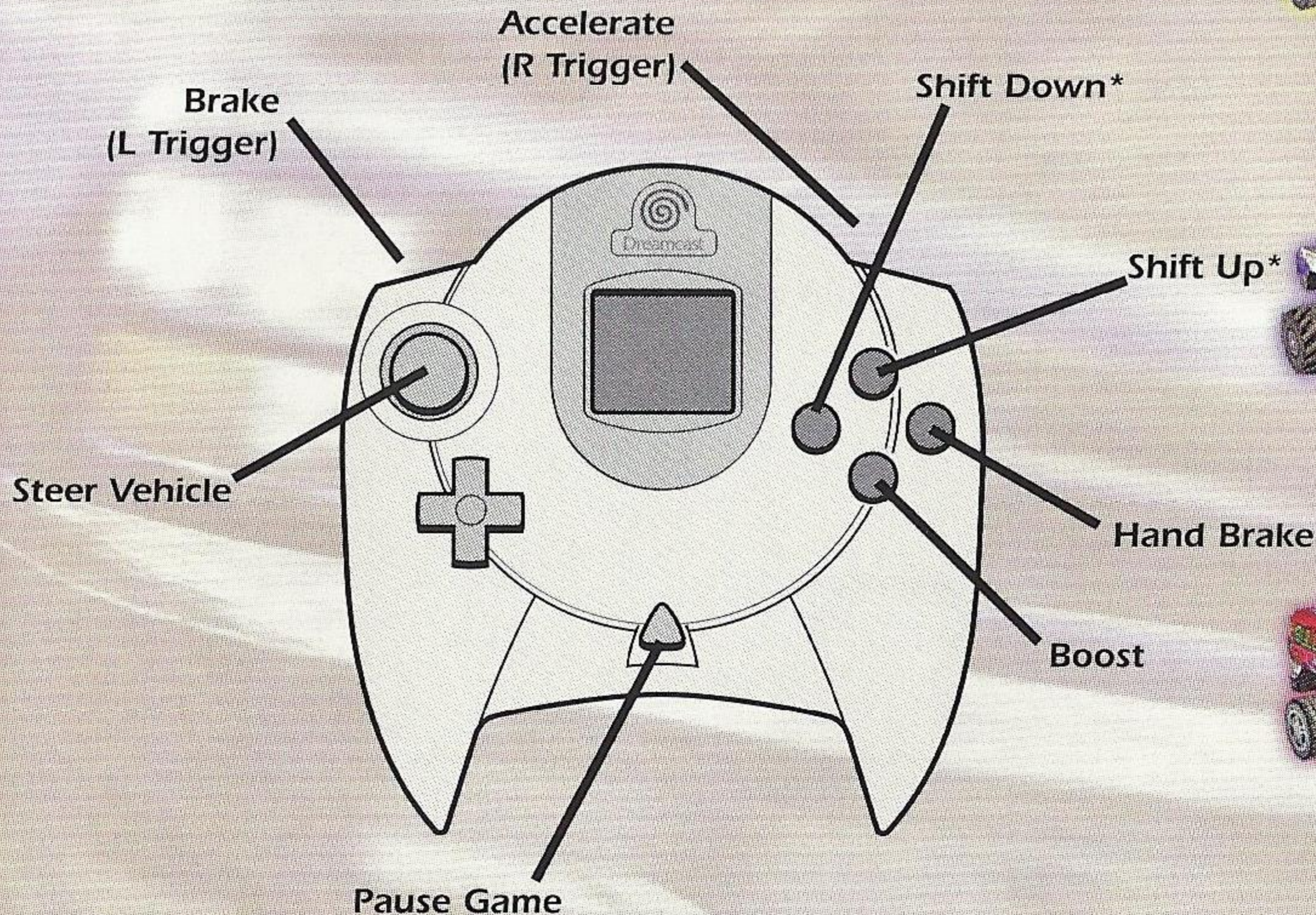

* This function is only available when using a Manual Transmission.

Well, those are the controls. Now that you're ready to go, let's show you how to play this game. Remember, if you want to change the controls, see Page 7!

PLAYING THE GAME

The information below will show you everything to look for on-screen while playing.



1.) Current Time Statistics

2.) Current Time On Track

3.) Current Race Statistics

4.) Vehicle Speed

5.) Boost Gauge

6.) Track Map

PLAYING THE GAME

You must collect Boost Icons to help you win each race. The Boost Icon acts as a power-up to give your vehicle a boost of speed. Keep your eye on your Boost Meter so that you don't run out when you need it. The Boost Meter can hold up to 20 seconds of Booster Fuel. There are two different types of Boost Icons:

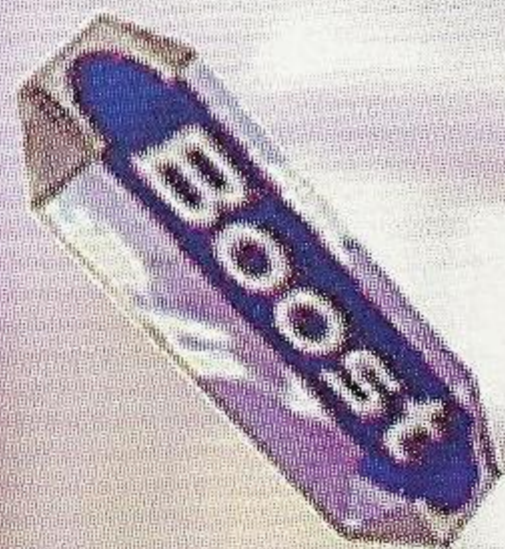

+4 SECONDS

This icon will add 4 Seconds to your Boost Meter.

+9 SECONDS

This icon will add 9 Seconds to your Boost Meter.

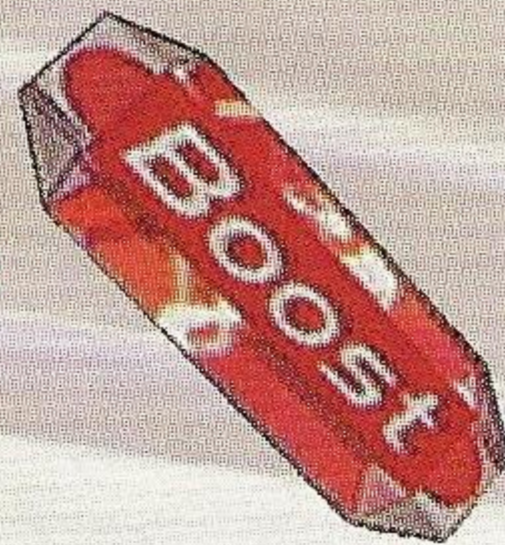

During the race, you will encounter Boost Icons all over the track. If you happen to miss one, don't worry, there's tons of them on each track. Most of the tracks have shortcuts and other secret paths you can use to jump ahead of the group or to find hidden items. Keep your eyes open for these paths. If you don't see a wall or other object blocking your way, odds are that you can drive there. So be adventurous, because you never know what you may find!



PLAYING THE GAME

While you are playing, it may become necessary to Pause the game. To do this, press the Start Button to access the Pause Menu. The following options are available to you:

SELECT CAMERA: Choose from different camera angles to view the race with. You can even use the **INSIDE** camera to view the race from the driver's seat.

MUSIC VOLUME: Adjust the volume of the background music.

SOUND VOLUME: Adjust the volume of the sound effects.

RESUME: Highlight this and press the A Button to return to the action. After adjusting options, you must highlight this to go back to the race.

RETRY THE COURSE: This will begin the race all over again. This is good when you are really far behind. Note: This option is **NOT** available in Championship Mode races.

RETIRE: Quits the current race and exits you back to the previous menu.

Each option can be adjusted by pressing Up and Down on the Direction Button or Analog Thumb Pad to highlight it, then pressing Left and Right to adjust. If you leave the game paused for too long, the screen will darken. This is perfectly normal and is meant to protect your television. Simply press the Direction Button or Analog Thumb Pad to deactivate the screen saver.

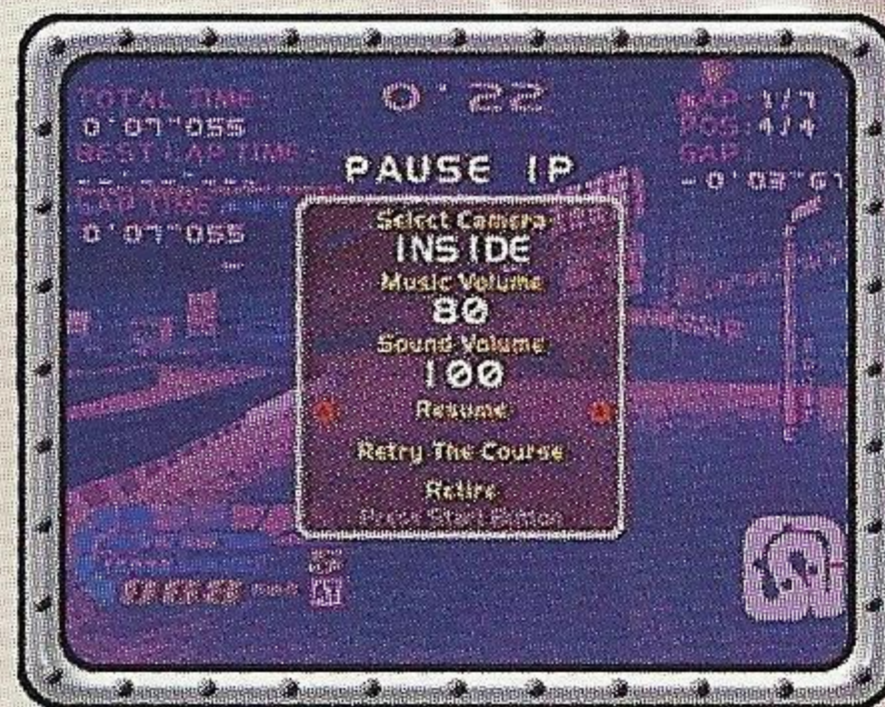

PRACTICE MODE

At the Main Menu, select PRACTICE and press the A Button.

Practice Mode allows you to select from a group of tracks and vehicles (more tracks and vehicles are available once they are unlocked) to practice your driving skills. It is highly recommended you use this mode to get a feel for a certain track or vehicle before entering an Arcade Mode or Championship Mode race. Practice Mode also features a few options you can adjust before hitting the raceway:

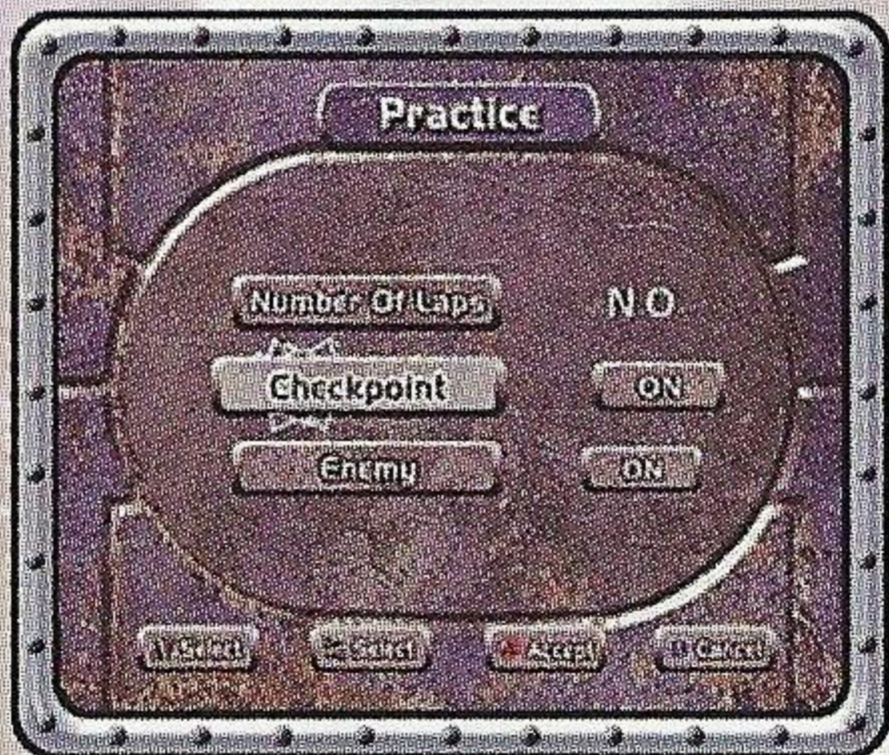

NUMBER OF LAPS: To set the number of laps, you must set the ENEMY to OFF. This will allow you to race up to 10 laps with no other racers on the track.

CHECKPOINT: The Checkpoints in the track can be turned ON or OFF. When playing with the Checkpoints ON, you must reach a Checkpoint to add more time to your race clock. If the timer expires before you reach the

Checkpoint, your game is over. When playing with the Checkpoints turned OFF, you don't have to worry about the time running out.

ENEMY: With the Enemy set to ON, you will be racing against AI vehicles with the same lap count you will find in Arcade and Championship Modes. With the Enemy set to OFF, you can race by yourself and set the desired lap count up to 10 laps.

Each option can be adjusted by highlighting it and pressing Left or Right on the Direction Button or Analog Thumb Pad. When you are ready to race, press the A Button.



ARCADE MODE

ARCADE MODE is your standard "pick and play" game mode. There are two sets of tracks in Arcade Mode. Arcade 1 features all indoor tracks, Arcade 2 features a set of outdoor tracks. At the Main Menu, select ARCADE INDOOR or ARCADE OUTDOOR and press the A Button.

Arcade Mode is an intense way of playing the game. The first thing you will do is select a vehicle. Remember, each vehicle in the game is not only different in appearance, but it will also handle differently than another vehicle (even those of the same design). Try to match your vehicle with the track conditions you will face.

When racing, the object is to come in First Place in order to advance to the next track. You must win each race before you can advance to the next race. Arcade Mode (both Indoor and Outdoor) tracks are split into three different series of tracks. In order to advance to the second series of tracks, all races in the first series must be won. The third series of tracks can only be accessed once you have won all of the tracks in the second series!

After the race is over, you can record your time for the Hall of Fame and save your progress to your VMU (if one is inserted). Once you have won a race and if you can win in a record time, you will be able to enter your initials for the Hall of Fame. Use the Direction Button or Analog Thumb Pad to scroll through the letters. Once you have entered your initials, press the A Button to continue. After you have finished the race (and entered your initials), you will see the Save Game screen. Access the VMU you wish to save to and press the A Button. Highlight SAVE and press the A Button again. When your information is saved, press the B Button to return to Arcade Mode.

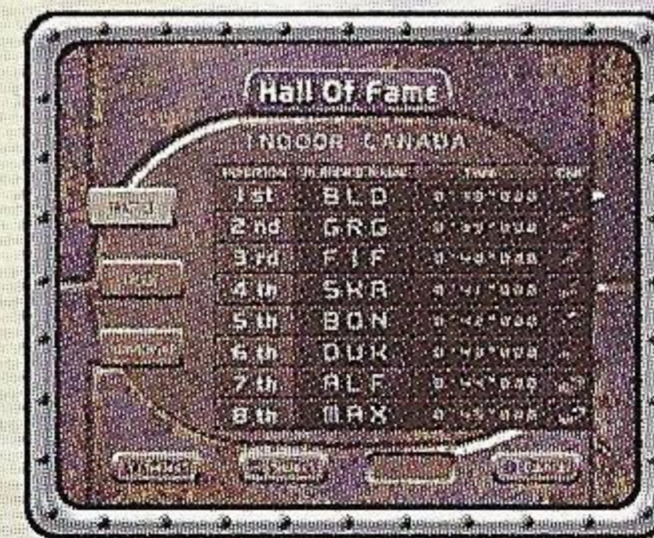

Hall Of Fame

INDOOR CANADA

POSITION	INITIALS	TIME	TIME
1st	BLD	0:19:000	
2nd	GRC	0:21:000	
3rd	FIF	0:24:000	
4th	SHR	0:27:000	
5th	BON	0:30:000	
6th	DUR	0:33:000	
7th	RLF	0:36:000	
8th	MAX	0:39:000	

CHAMPIONSHIP MODE

CHAMPIONSHIP Mode allows you to enter your name, choose a car and then hit the Championship circuit. Depending upon what place you finish the race in (First, Second, Third or Fourth), you will win a cash amount. These cash amounts can be used to upgrade your vehicle for better performance. Select CHAMPIONSHIP from the Mode Menu and press the A Button.

The first thing you will do is enter a name for yourself. Using the Direction Button or Analog Thumb Pad, move the cursor to the letter or number you wish to enter and then press the A Button. Your name can only be three characters in length.

Next, you will be shown the track you will be competing on. You will also see a chart displaying the current rankings of the circuit. The chart displays each racer's name, score and car they are using. Once you have checked out the track and standings chart, press the A Button to advance to the Vehicle Select screen.

You will only be able to choose from the 8 base vehicles to begin your career. Keep in mind that each track will be different, therefore every vehicle will handle each track differently. This is where playing Practice Mode comes in handy. Try to pick a well-rounded vehicle to use. By finishing races, you can earn money to upgrade your vehicle. It is important to note that when playing a Championship game, you will only be able to use the same vehicle in every race. To change your vehicle you must begin a new game. If you exit out of a Championship game and you do not save your progress, all game data will be lost. So make sure you save your games!



CHAMPIONSHIP MODE



When you race in the Championship circuit, the object is (besides trying to come in First Place) to win and earn as much cash as possible. You can win cash by finishing races (prize amounts depend on what place you finished the race) and by finding special cash icons on the track. Cash Icons can only be picked up once during the race, unlike Boost Icons which can be picked up multiple times.



After each race you will be shown your totals. These totals include points awarded for the race, what position you finished the race in and how much money you have. The cash you win is used to upgrade or customize your current vehicle. After each race (after you have seen the next track you will be racing on), you will go back to the garage (vehicle screen). On the left of the screen you will see how much money you have and the total amount of money you will need to customize your vehicle.



When starting the game, you will only be able to select from 8 different vehicles. There are 4 different styles of vehicle, each with 5 levels of customization. When you customize a vehicle you are basically unlocking another vehicle.



To customize your vehicle, you will need the cash to do it. Once you have obtained enough cash to upgrade, you will automatically be able to customize by highlighting CUSTOMIZE on the right of the screen and pressing the A Button.

JACKPOT!

Randomly after you complete a Championship Mode race, you will be able to play a slot machine in order to win more money. If you can connect three icons in a row, you will win a \$3000 jackpot! It may be an easy way to get some more money in your bank account, but it will also cost you \$100 a shot!

When the slot machine appears on screen, you can either pull the lever (press the A Button) or cancel out and save your money (press the B Button). It can get expensive trying to win that jackpot, but the payoff is usually worth it. If you try to play 10 times in a row (10 times is the maximum amount of tries) and you still don't win anything, you will be awarded a special bonus just for trying.



TWO PLAYER GAMES

In order to play against a friend, either player must select 2 PLAYER from the Main Menu and press the A Button. Both players can control menus in the game.

Every game mode is available for both players. This means that two players can enter a Championship, play an Arcade race and even Practice together. Playing the game with two people is no different from a single-player game. The only difference is that the screen is split into two sections. Player 1 is on top, while Player 2 is located on the bottom of the screen. All on-screen displays stay the same.



Probably the greatest thing about 2-Player games are the Special Modes available to you. There are four Special Modes that are great "One on One" games. Check out the next few pages to learn more about them.

TWO PLAYER GAMES

BOMB!

BOMB! is the first of four 2-Player Special game modes. Select BOMB! from the Special Modes menu and press the A Button.

BOMB! is basically a tag game. When the match starts, one player will have a bomb attached to their vehicle. The bomb has a timer on it and when the timer runs out, the bomb explodes (along with your vehicle)!

Before you start a match, you can adjust the following options:

COUNTDOWN: Set the timer on the bomb from 10-60 seconds. The timer works in increments of 5 seconds.

VICTORY: Select from 1-5. This controls the number of victories needed to win the series. For example, if you set the victories to 4, the player who wins 4 matches is the winner.

After you have set the options for your match, it's time to select a track to play on. There are 5 tracks to choose from. After you have selected the track, the players may choose what vehicle they want to use. If you have any unlocked vehicles, you can use them here. Player 1 chooses first, followed by Player 2.



TWO PLAYER GAMES

BOMB RACE

BOMB RACE is the second of four 2-Player Special game modes. Select BOMB RACE from the Special Modes menu and press the A Button.

BOMB RACE is your basic 2-Player race with a twist. The player that is lagging behind has a bomb attached to their car. The bomb has a timer on it as well. If the player who is in last place doesn't pass the lead player in the time allowed, they will explode. The object is to pass your opponent to gain the lead, as well as pass the bomb off to them!



Just like the BOMB! game, Bomb Race has options you can adjust as well.

LAPS: Select the number of laps you will have in your race. You can choose from 1-10 laps.

CHECKPOINT: Turn the Checkpoints (timers) ON or OFF.

COUNTDOWN: This sets the timer on the bomb. Choose from 10-60 seconds.

VICTORY: This controls the number of victories needed to win the series. Select from 1-5.

Bomb Race features a total of 6 tracks for you to race on. Like the BOMB! game, each player can select any unlocked vehicle.

TWO PLAYER GAMES

BALLOON

BALLOON is the third 2-Player Special game mode. Select **BALLOON** from the Special Modes menu and press the A Button.

The object of Balloon is to race around the track and collect colored balloons. Each balloon adds 2 seconds to your timer. The first player to run out of time loses the race. If both players are not able to collect balloons and their time runs out, the player who has progressed furthest on the track is the winner. The Balloon game mode features three options you can adjust.

NUMBER OF LAPS: Set the number of laps in the race from 1-10.

START TIME: This determines how much time will be on the clock when you begin the race. You can select anywhere (in 5 second increments) from 5 seconds to 30 seconds.

VICTORY: Select from 1-5 rounds needed to become the winner of the series.



TWO PLAYER GAMES

TAG MODE

TAG MODE is the fourth 2-Player Special game mode. Select TAG MODE from the Special Modes menu and press the A Button.

Just like BOMB!, Tag Mode is a game of tag (without explosives). This time the object of the game is to NOT be tagged. As you begin the game, a trophy will be located somewhere on the track. The player who grabs the trophy must keep the trophy for the duration of the race. You can adjust how much time will be in each round under the Tag Mode options menu. The player who holds the trophy for the longest time total during the race is the winner. There are two options you can adjust for Tag Mode.

TIME LIMIT: Set the time limit of each round from 10 seconds to 120 seconds.

VICTORY: Choose a number of rounds (1-5) needed to be the winner of the series.

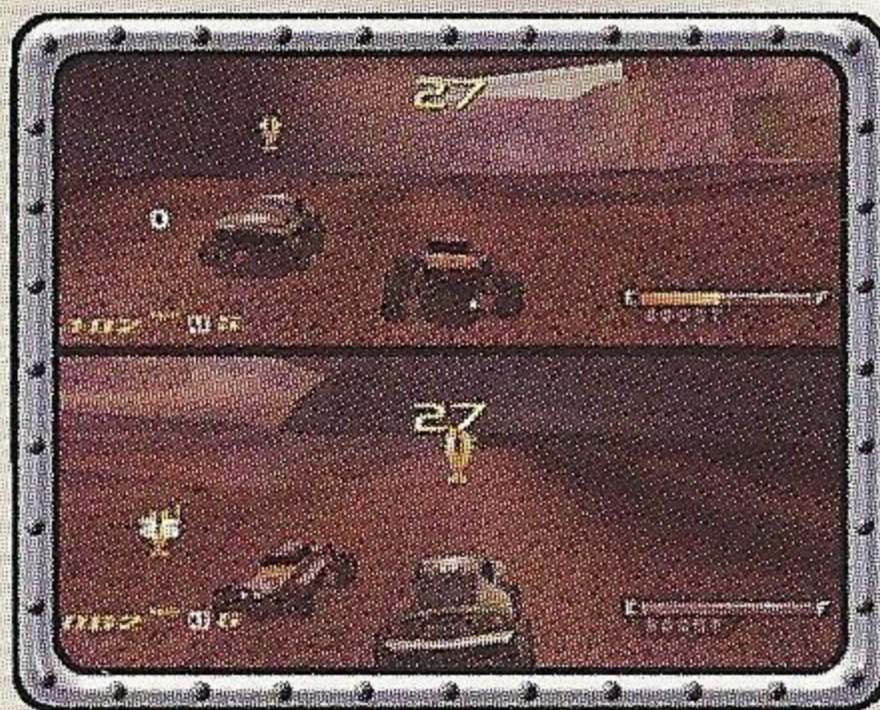

4 WHEEL HINTS

You may need a few tips before you hit the racing circuit. Here's a few hints to help you out.

- Try to conserve your booster fuel. You never know when you might need it.
- Explore the tracks. You'll find that there are a number of paths to explore and you just might find a shorter route to the finish line.
- Look closely for booster fuel. There are several areas in the track that have boost icons that might help you reach the finish line faster.
- At the beginning of a race, try pressing the Accelerate and Boost buttons in a specific order. If you do the combination correctly, you'll be rewarded with a Super Start.
- Practice with each vehicle. You'll find out that they all handle differently, but each one does have their own advantages and disadvantages when it comes to racing.
- Can't finish a series? Try looking up codes in magazines or on the internet. These are great references for unlocking all of the tracks!



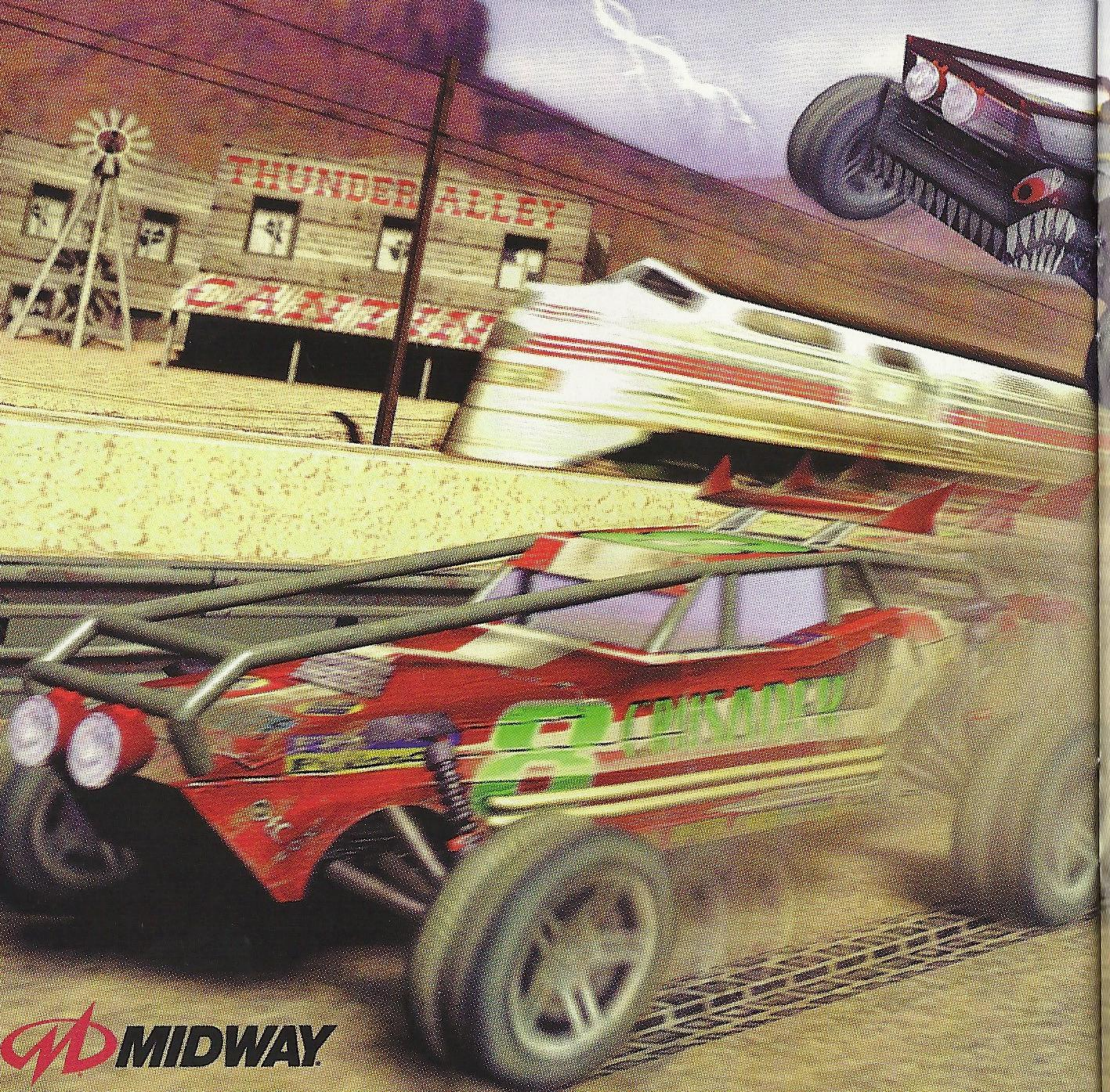

WD MIDWAY

4 WHEEL THUNDER™

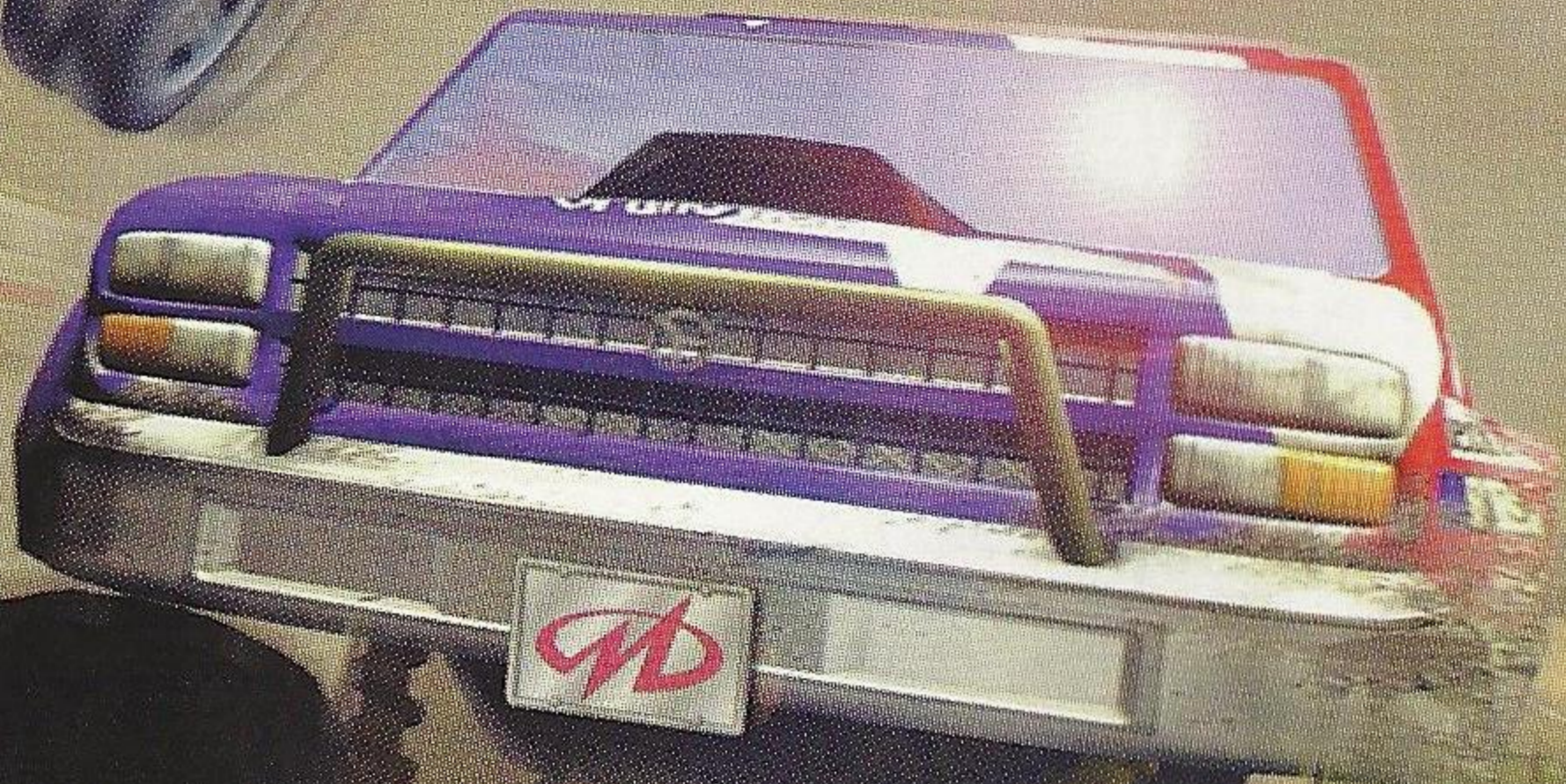

CREDITS

MIDWAY HOME ENTERTAINMENT

PRODUCER

Dave Brooks

ASSOCIATE PRODUCER

Will Shen

ASSISTANT PRODUCER

Erwin Gasmin

TECHNICAL DIRECTOR

Sam Calis

PRINT DESIGN & PRODUCTION

Midway Creative Services

San Diego

PRODUCT MANAGER

Derryl DePriest

TEST MANAGER

Hans Lo

TESTING SUPERVISOR

Jeff Greenhut

LEAD PRODUCT ANALYST

Dan Wagner

TECHNICAL STANDARDS ANALYSTS

Jason Dickson & Shon

Flanagan

PRODUCT ANALYSTS

Brian Golding, Eric Rose, Jim Dunne,
Josh Stacy, Rob Parnell, Steve Scott, Virgillio
Abad, Steve Cupp, Josh Hutchins, John Tajuna,
Jason Jorgensen, Steve Carson & Federico Digo Jr.

SPECIAL THANKS

Deborah Fulton, Kathy Lange, Kathy
Schoback, Izora Lillard, Teri Higgins,
Ed Duran & Matt Vella

CREDITS

KALISTO ENTERTAINMENT PRODUCTIONS

PRODUCTION TEAM

GAME MANAGER

Emmanuel Nouaille

PRODUCTION ASSISTANT

Julie Taylor

COACH PROGRAMMER

Philippe Rivailon

PROGRAMMERS

Frederic Brunel, Gregory Garcia,
Gregory Jan, Jean-Sebastien Dasse,
Cedric Julien & Roland Lacoste

SCRIPTER

Arnaud Lewden

COACH ARTIST

Maxime Deleris

ARTISTS

Emmanuel Correia, Jean-Francois Hugon,
Christian Diaz, Adrien Delaboudiniere,
Alfio Trabuio, Damien Papet, Olivier Triboulloy,
Marc Moreno, Hugo Palasie, Mathieu Michel,
Cyril Moreul, Virginie Ropars, Yi Moua Chong Yong,
Daniel Roger & Michel Roger

PUBLIC RELATIONS

Laetitia Jauze

PRODUCT MANAGER

Stephanie Rolland-Latorzeff

POST PRODUCTION

Olivier Bailly-Maitre

MUSIC & SOUND EFFECTS

Frederic Motte



CREDITS

KALISTO ENTERTAINMENT PRODUCTIONS

CINEMATICS

ARTIST DIRECTOR

Frederic Levistre

ANIMATOR DIRECTOR

Nicolas Messyasz

ANIMATOR

Sandrine Herve

ARTISTS

Antoine Guilband, Franck Manon,
Gwen Heliou, Laurent Fisher, Nicolas Rivière,
Philippe Courdille, Sebastien Froncek & Sébastien Larrue

QUALITY DEPARTMENT

Q.A. MANAGER

Pascal Lempereur

TEST MANAGER

Jerome Antona

LEAD ANALYST

Pascal Salngre

LEAD ANALYST SUPPORT

Jerome Braune

MAIN ANALYST & CAR ADJUSTMENT

Arnaud Paraire

SPECIAL THANKS

Fabrice Tete, Frederic Lavignasse, Ludivine Doleux, Ludovic Dubois,
Loic Lepage, Will Davis, Olivier Robin, DIFINTEL, Stephane Munuera,
Nicolas Sanchez, TE. REC, Jean-Francois Lopez, Serge Plagnol, Jose
Caparros, CNM-Philippe Seban, Tashin Tamer, Sebastien Viannay, Elton
Bird, Thomas Szirtes, Scopiton & Mr. Paul Bandey, James Anderson,
Alain Guyet, David Gallardo, Grand Angle (Jean-Luc Millan),
Xavier Delpauch, Dave Brooks, Will Shen & Erwin Gasmin

WARRANTY

MIDWAY HOME ENTERTAINMENT INC. warrants to the original purchaser of this Midway Home Entertainment Inc. software product that the medium on which this computer program is recorded is free from defects in materials and workmanship for a period of ninety (90) days from the date of purchase. This Midway Home Entertainment Inc. software program is sold "as is," without express or implied warranty damages of any kind, and Midway Home Entertainment Inc. is not liable for any losses or damages of any kind resulting from the use of this program. Midway Home Entertainment Inc. agrees for a period of ninety (90) days to either repair or replace, at its option, free of charge, any Midway Home Entertainment Inc. software product, postage paid, with proof of purchase, at its Factory Service Center.

This warranty is not applicable to normal wear and tear. This warranty shall not be applicable and shall be void if the defect in the Midway Home Entertainment Inc. software product has arisen through abuse, unreasonable use, mistreatment or neglect. THIS WARRANTY IS IN LIEU OF ALL OTHER WARRANTIES AND NO OTHER REPRESENTATIONS OR CLAIMS OF ANY NATURE SHALL BE BINDING ON OR OBLIGATE MIDWAY HOME ENTERTAINMENT INC. ANY IMPLIED WARRANTIES APPLICABLE TO THIS SOFTWARE PRODUCT, INCLUDING WARRANTIES OF MERCHANTABILITY AND FITNESS FOR A PARTICULAR PURPOSE, ARE LIMITED TO THE NINETY (90) DAY PERIOD DESCRIBED ABOVE.

IN NO EVENT WILL MIDWAY HOME ENTERTAINMENT INC. BE LIABLE FOR ANY SPECIAL, INCIDENTAL, OR CONSEQUENTIAL DAMAGES RESULTING FROM POSSESSION, USE OR MALFUNCTION OF THIS MIDWAY HOME ENTERTAINMENT INC. SOFTWARE PRODUCT.

Some states do not allow limitations as to how long an implied warranty lasts and/or exclusions or limitations of incidental or consequential damages so the above limitations and/or exclusions of liability may not apply to you. This warranty gives you specific rights, and you may also have other rights which vary from state to state.

Midway Home Entertainment Inc.
P.O. Box 2097
Corsicana, TX 75151-2097
www.midway.com

Midway Customer Support
903 874-5092
10:00am - 6:30pm / Central Time
Monday - Friday
Automated help line open 24 hours a day

ESRB RATING

This product has been rated by the Entertainment Software Rating Board. For information about the ESRB rating, or to comment about the appropriateness of the rating, please contact the ESRB at 1-800-771-3772.

Sega is registered in the US Patent and Trademark Office. Sega Dreamcast, the Dreamcast Swirl, are trademarks of SEGA. Sega of America, P.O. Box 7639, San Francisco, CA 94120. All Rights Reserved. Programmed in Japan. Made and printed in the USA. WARNING: Operates only with NTSC televisions and Sega Dreamcast systems purchased in North and South America (except Argentina, Paraguay and Uruguay). Will not operate with any other televisions or Sega Dreamcast systems. Product covered under one or more of the following U.S. Patents: 5,460,374; 5,525,770; 5,627,895; 5,688,173; 4,442,486; 4,454,594; 4,462,076; Re. 35,839; Japanese Patent No.2870538, (Patents pending in U.S. and other countries); Canada Patent No. 1,183,276. The ratings icon is a trademark of the Interactive Digital Software Association.

SEGA®



MIDWAY
www.midway.com

MIDWAY HOME ENTERTAINMENT
P.O. Box 2097 Corsicana, TX 75151-2097

4 WHEEL THUNDER © 2000 Kalisto Entertainment. All rights reserved. Developed by Kalisto Entertainment. 4 WHEEL THUNDER is a trademark of Midway Home Entertainment Inc. MIDWAY is a trademark of Midway Amusement Games, LLC. Used by permission. Distributed under license by Midway Home Entertainment Inc.

Sega is registered in the US Patent and Trademark Office. Sega Dreamcast, the Dreamcast Swirl, are trademarks of SEGA. Sega of America, P.O. Box 7639, San Francisco, CA 94120. All Rights Reserved. Programmed in Japan. Made and printed in the USA. WARNING: Operates only with NTSC televisions and Sega Dreamcast systems purchased in North and South America (except Argentina, Paraguay and Uruguay). Will not operate with any other televisions or Sega Dreamcast systems. Product covered under one or more of the following U.S. Patents: 5,460,374; 5,525,770; 5,627,895; 5,688,173; 4,442,486; 4,454,594; 4,462,076; Re. 35,839; Japanese Patent No.2870538; (Patents pending in U.S. and other countries); Canada Patent No. 1,183,276. The ratings icon is a trademark of the Interactive Digital Software Association.

kalisto
ENTERTAINMENT

www.kalisto.com

SEGA®