

VS. BASEBALL

(Operation Manual)

I. How to install Software ROMs

Each Software ROM is labeled with a Location Number shown on it ( Shaded Portion illustrated below), which will indicate the corresponding location on the P.C. Board where it should be installed.



(Label on Software ROM)

“VS. Baseball” contains 12 Software ROMs, and 2 Custom ICs, which have location numbers, 1A, 1B, 1C, 1D, 2A, 2B, 6A, 6B, 6C, 6D, 8A, 8B, 2F and 8F. Each ROM and IC must be mounted into the proper IC Socket.

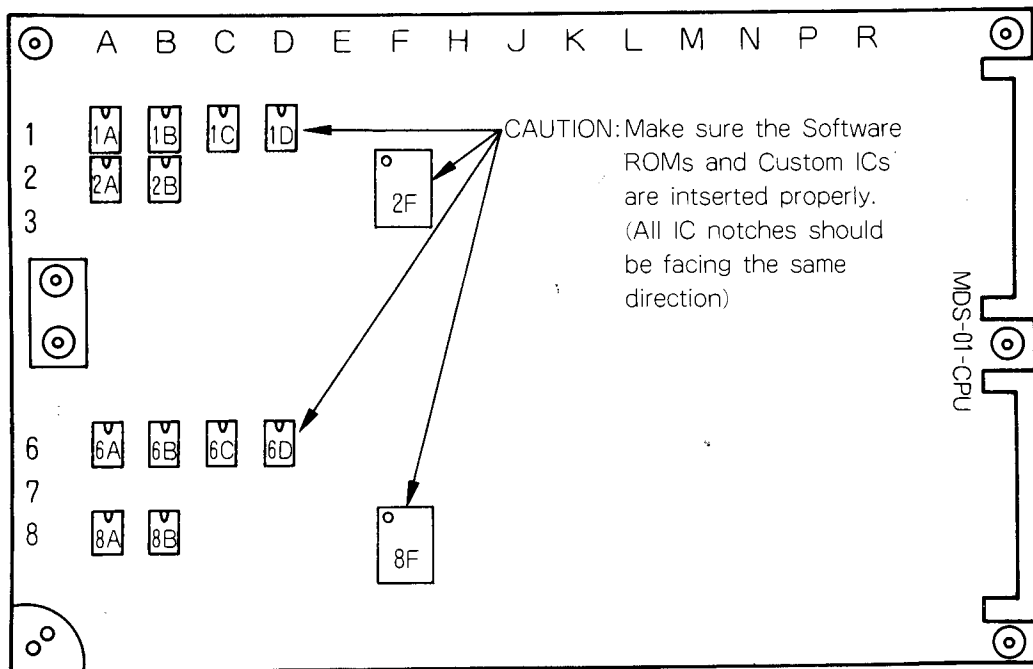

ROM and IC Location P.C. Board

Caution: New Software ROMs or Custom ICs can only be mounted once the old Software ROMs or Custom ICs have been removed from their Sockets.

2. Points and methods of adjustment

MDS P.C. Board

Game Option Settings

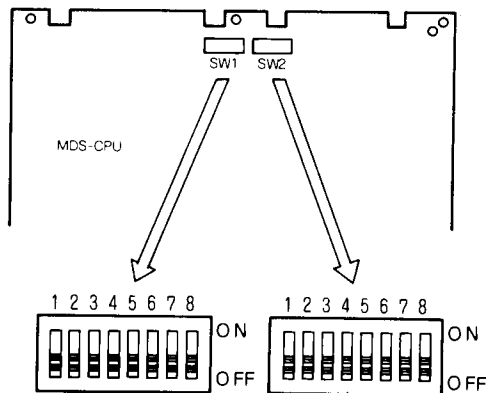

		Switch (SW1) Settings							
		1	2	3	4	5	6	7	8
Player Defense Strength	(Weak) 1	OFF	OFF						
	2	OFF	ON						
	3	ON	OFF						
	(Strong) 4	ON	ON						
Player Offense Strength	1			OFF	OFF				
	2			OFF	ON				
	3			ON	OFF				
	4			ON	ON				
Computer Defense Strength	1					OFF	OFF		
	2					OFF	ON		
	3					ON	OFF		
	4					ON	ON		
Computer Offense Strength	1							OFF	OFF
	2							OFF	ON
	3							ON	OFF
	4							ON	ON

Note: For Strength Settings, 1 is easy and 4 is hard.

		Switch (SW2) Setting							
		1	2	3	4	5	6	7	8
Game Mode	Test Mode	OFF							
		ON							
Coin/Credit	1 / 1		OFF	OFF					
	1 / 2		OFF	ON					
	2 / 1		ON	OFF					
	FREE		ON	ON					
Initial PTS. Setting	80				OFF	OFF	OFF		
	100				OFF	OFF	ON		
	150				OFF	ON	OFF		
	200				OFF	ON	ON		
	250				ON	OFF	OFF		
	300				ON	OFF	ON		
	350				ON	ON	OFF		
400				ON	ON	ON			
Bonus Play	Bonus							OFF	
	No Bonus							ON	
Attract Music	No Music								OFF
	Music								ON

3. Test Mode

(1) Entering Test Mode

Make sure the main power switch is in the "OFF" position.

Set for "Test Mode" by the switching Toggle 1 (SW2) on the game P.C. Board to the "ON" position. Now turn the main power switch to the "ON" position.

(2) Memory Test

All ROM and RAM will be tested automatically, and the test result will be displayed on the Video Monitor, with Green meaning "OK", Red meaning "NG", and Yellow meaning "NOT IN IC SOCKET".

Also, the memory back-up condition can be tested, and the result will be displayed on the Video Monitor as a Battery illustration. On power up, "BATT" section will be Red. Turn the power off for 5 seconds, then turn back on. "BATT" section will now be Green if good, and still Red if not good.

Pressing the Service Switch will step to the next test. ("Switch Test")

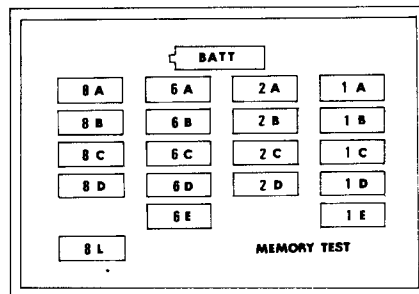

(3) Switch Test

All Control Levers, Game Buttons, and Dip Switches can be tested at this time. The screen should show a picture of the control lever and the game buttons, along with the Dip switch. The picture corresponding to the switch being tested will appear GREEN if in the "OFF" position, and RED if in the "ON" position. The Dip Switch setting are shown on the right side of the screen and indicate which switches are ON and/or OFF. Pressing the service switch will step to the next test. (CRT & Sound Test)

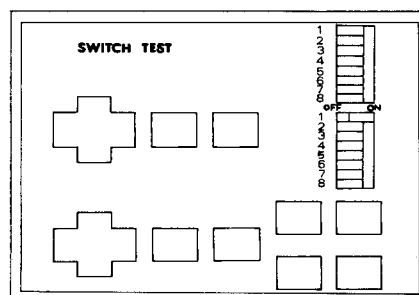

(4) CRT and Sound Test

a) CRT Test

The test pattern shown in Fig. 1 will appear on the screen.

This pattern is used for adjusting color convergence. Moving a control lever up or down will change the test pattern to an all white screen shown in Fig. 2. This pattern is used for adjusting color purity. (screen should be pure white.)

Moving the control lever again will put the first pattern back on the screen, if desired.

b) Sound Test

The different sound circuits can also be tested at this time.

Pressing a "B" button or a "1" or "3" button will start a corresponding sound test. To stop the test, press the "A" button or the "2" or "4" button.

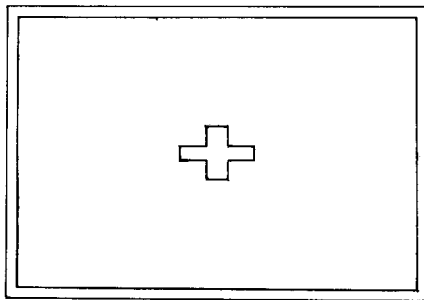

Fig. 1

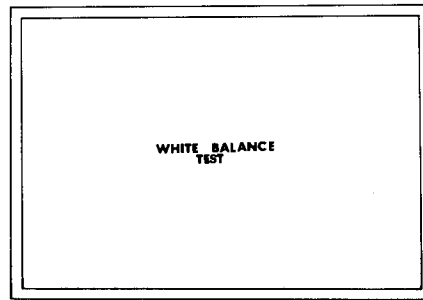

Fig. 2

(5) Return to Game Mode

Turn the main power switch to the "OFF" position. Reset back to "Game Mode" by switching Toggle 1 (SW2) on the P.C. Board back to the "OFF" position. Now turn the main power switch to the "ON" position.

CAUTION

The suggested factory settings for VS.BASEBALL™ are listed below. It is recommended that you carefully check the DIP switch settings prior to operation.

SW1 settings								SW2 settings							
1	2	3	4	5	6	7	8	1	2	3	4	5	6	7	8
on	off	on	off	off	on	off	on	off	off	off	off	on	on	off	off

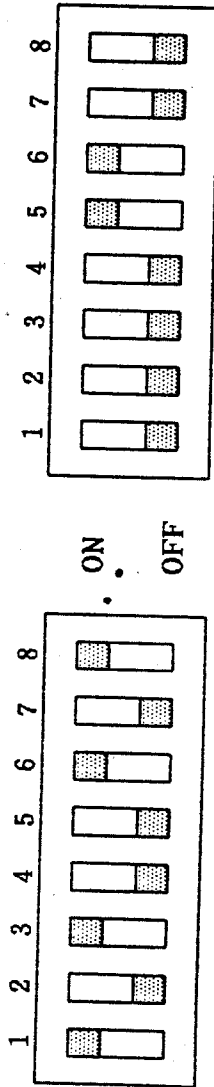

Please review the DIP switch label for further information.

Nintendo of America Inc.