

Laser

Fantasy

**SERVICE MANUAL
(UPRIGHT)**

FUNAI // ESP

INTRODUCTION FOR MANUAL

We are very much appreciated for your using "INTER STELLAR", the 1st series of LASER FANTASY.

INTER STELLAR have been developed on our latest technology and experience, thus we put our full confidence on it. Three-dimensional computer graphic is adopted for display as well 4 channel sound system for music, and this is an innovating game machine compared with conventional video-games. We are confident that you will be fully satisfied with it.

This manual is so edited aiming for engineers who are specialized for IC, CRT, LASER DISC and so on that particular caution has to be paid not to perform any service work inside of the system except by speciality engineers.

In case when it gets wrong, users in general are strictly requested not to touch anything inside of the game machine, electrical circuit, laser disc player for instance.

Warning – This equipment generates, uses, and can radiate radio frequency energy and if not installed and used in accordance with the instructions manual, may cause interference to radio communications. It has been tested and found to comply with the limits for a Class A computing device pursuant to Subpart J of Part 15 of FCC Rules, which are designed to provide reasonable protection against such interference when operated in a commercial environment. Operation of this equipment in a residential area is likely to cause interference in which case the user at his own expense will be required to take whatever measures may be required to correct the interference.

CONTENTS

1. Specification
2. Installation
3. Handling
4. Naming of each sections
5. Naming of inside of machine
6. Explanation of inside of machine
 - 6-1) Plate of power source
 - 6-2) AC outlet terminal
 - 6-3) Switch board
7. Installation of Laser disc player
8. Explanation on self-test
9. Adjustment of CRT Monitor
10. Dip switch table
11. Game procedure
12. Cleaning of filter

1. Specification

Power source	AC 120V \pm 5 V (60 Hz)
Power consumption	210 W
Game fee	25 cents x 2 per game (available to change)
Dimensions	Width 706 mm Depth 780 mm Height 1750 mm
Weight	155 Kg
CRT Monitor	19 inch colour monitor

* Specification subjects to be changed without notice.

2. Installation

- (1) Due to containing precision system like CRT Monitor, Laser disc player and so on, caution has to be taken not to give big shock during transportation and installation.
- (2) This machine INTER STELLAR is made for placing indoor, and it is strictly prohibited to install outdoor. Even for indoor use following care must be taken for right usage.
 1. To avoid locating it under direct sun-shine, humid, dusty and water spattering places. If it should be showered with water, being afraid of electrical shock, power source must be cut immediately, dry thoroughly then switch on again.
 2. To avoid putting on places where it may hinder emergency activity, near to emergency exit, fire extinguisher and so on.
 3. Be sure to put on solid and horizontal base. When placing it on unstable and vibrating base it may not only cause damage to the machine but also cause dangerous circumstances.
 4. Earth terminal of the machine should be grounded without fail.
 5. Applied voltage can be AC 115V – 125V, but please be care to feed 120V or as nearest as possible on which the machine is designed. By using beyond the range of 115 – 125V, it will damage itself or even result fire, so maximum care must be paid on this point.
 6. Upon deciding installation spot, decline the cabinet to move to your desired point then fix with the fixing adjusters (2 points at the right and the left) and, at the same time, adjust height. Fix firmly on the floor.

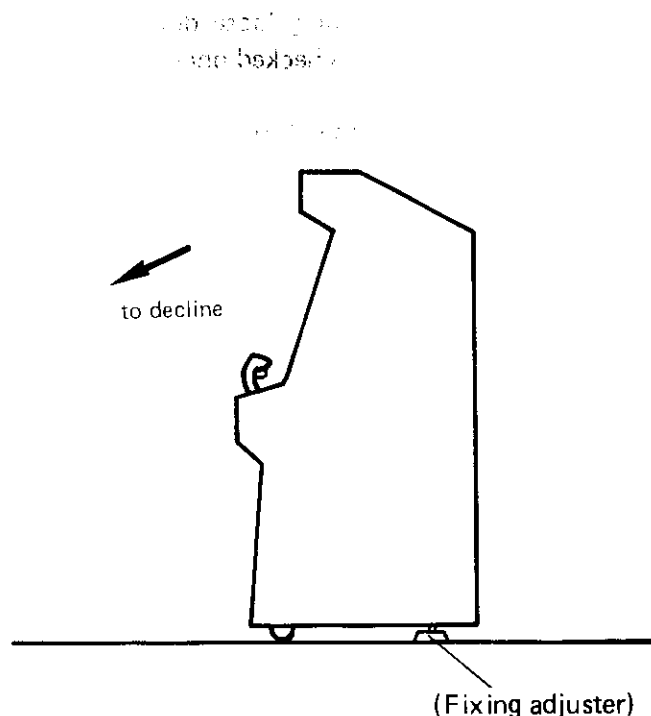

3. Handling

- (1) Due to containing precision system like CRT Monitor, Laser disc player and so on, caution has to be taken not to give big shock during transportation and installation.
- (2) Laser disc player should be fitted on the local spot and, for doing it, be sure to read through the pages of reference items.
- (3) For moving the machine from one place to the other, detouch the laser disc player, on which adapt fixing screws and lens cap, then pack and transport. When moving the player without the fixing screws and lens cap it may be damaged itself by vibration and dusts.
- (4) One should not touch inside of the player, which is very dangerous as being with high voltage and laser beam.
- (5) Laser disc player must be completely free from dusts, thus the disc and the filter (to refer p. 6, naming of inside of machine) must be cleaned once in fortnight without fail.
- (6) Laser disc can be handled like normal sound disc, do not touch the face directly.
- (7) High voltage is loaded on CRT Monitor, please be careful for inspection and adjustment.
- (8) Our specified fuses must be adapted. If otherwise is applied it may damage the machine and possibly cause fire (our ref. No. 1790382). When being cut frequently even with our specified one please cut power source and stop using the machine.
- (9) Each fixing points may probably be coming loose during transportation, and all the PC boards fitting, connectors and so on must be checked once again.
- (10) One must avoid applying circuit tester on the PC boards for inspection, for IC can be damaged even by internal voltage of the tester.
- (11) Cut power source when working on changing parts, putting connectors in and out and changing DIP SWITCH.
- (12) Please avoid to switch on immediate after cutting it off, for which one should wait at least 10 seconds.
- (13) For an event of voltage fluctuation CRT picture may stop sometimes. On that case, switch off once and put on again.

4. Naming of Each Sections

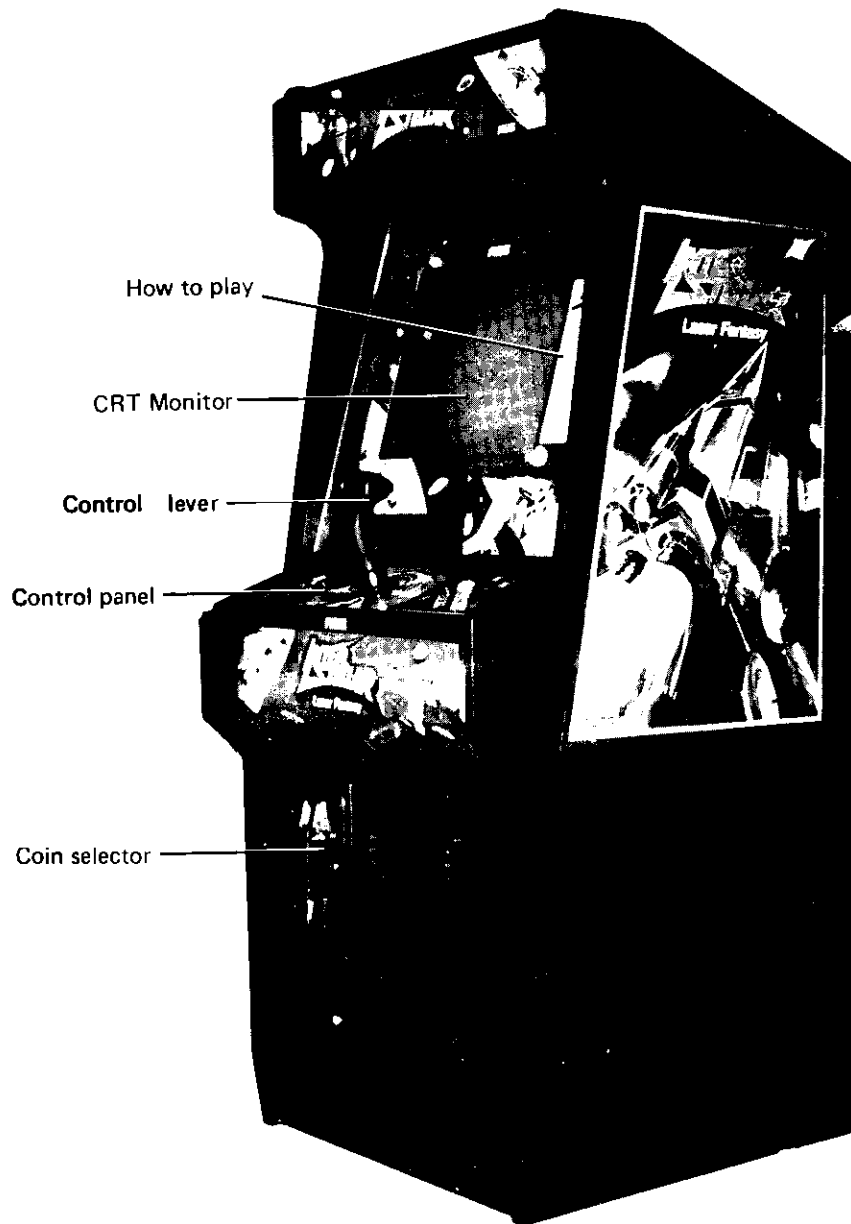

5. Naming of Inside of Machine

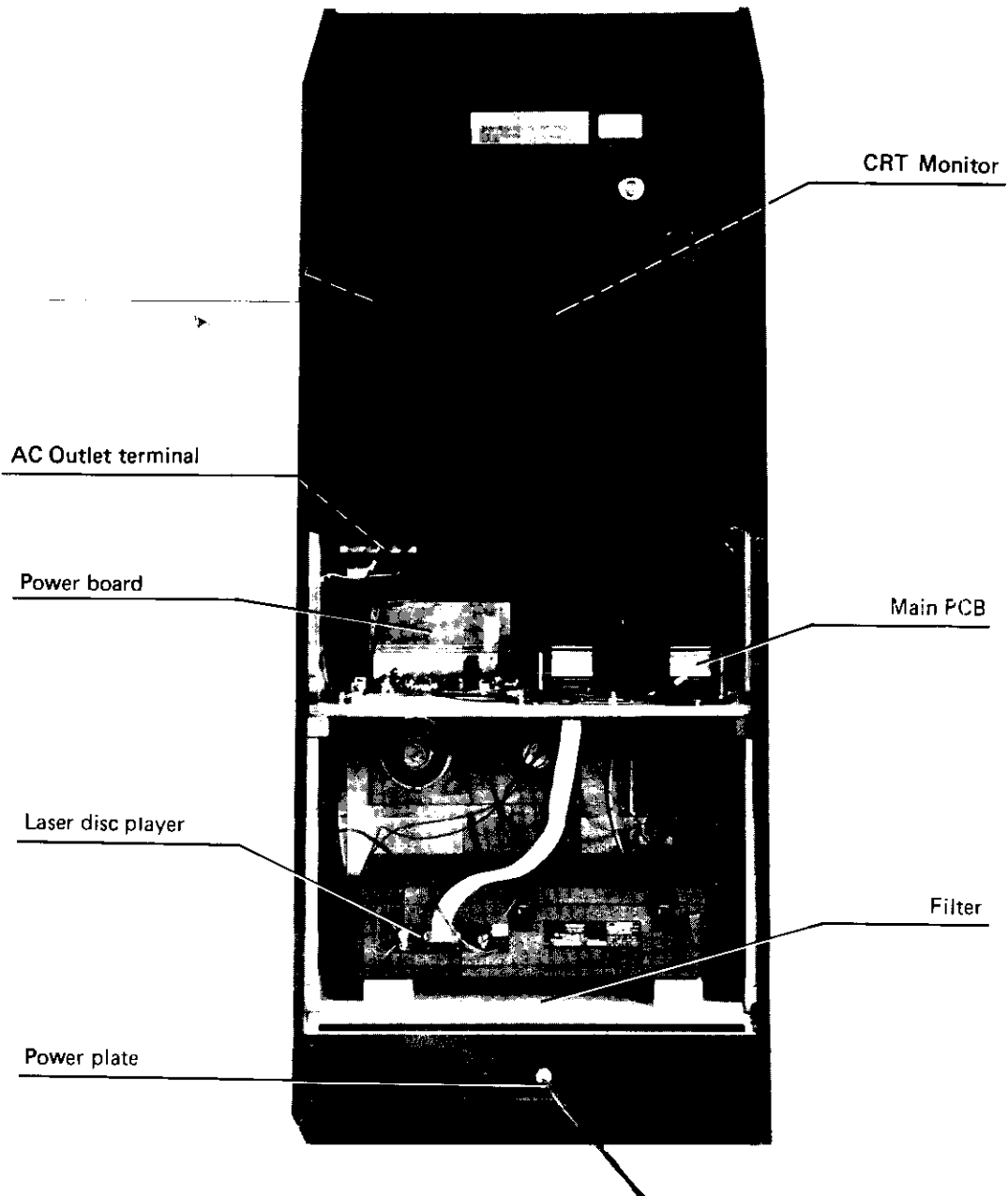

6. Explanation of Inside of Machine

6-1) Power plate

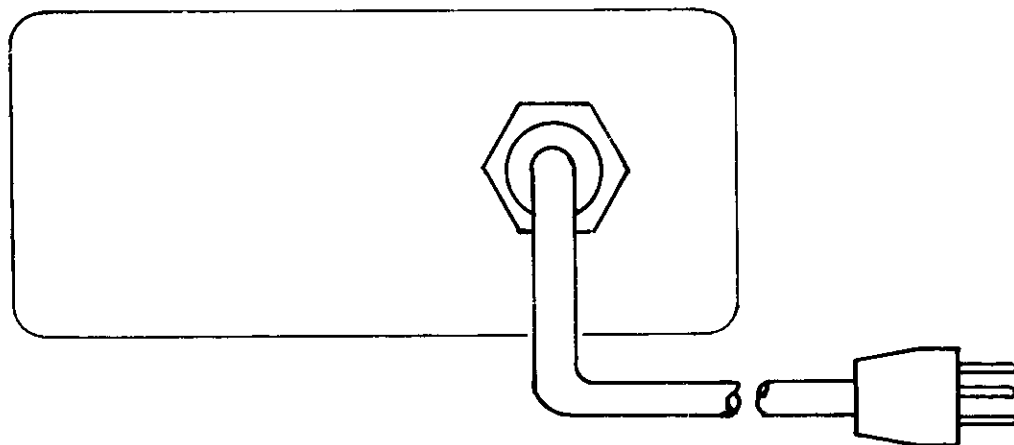

6-2) AC Outlet terminal

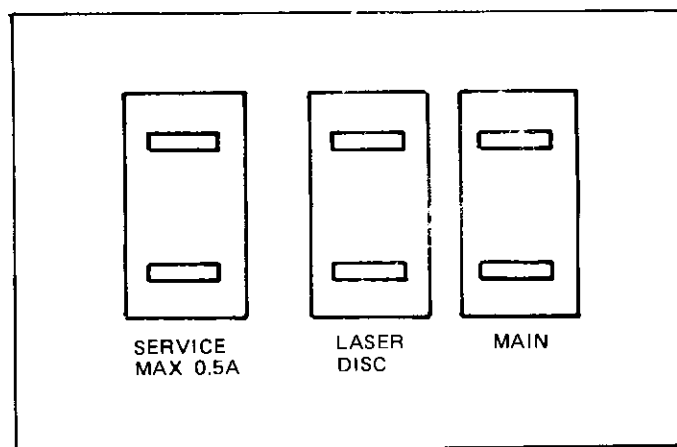

- Service Max. 0.5A – To be used for soldering iron and so on for service engineer
- LASER DISC – Specially for the laser disc
- MAIN – MAIN power socket for CRT Monitor, PC boards, fan and illumination lamp.

6-3) Switch board

- Unlock the key located upper side of the coin selector, open the door and you will find the switch board, with which following operation can be done.

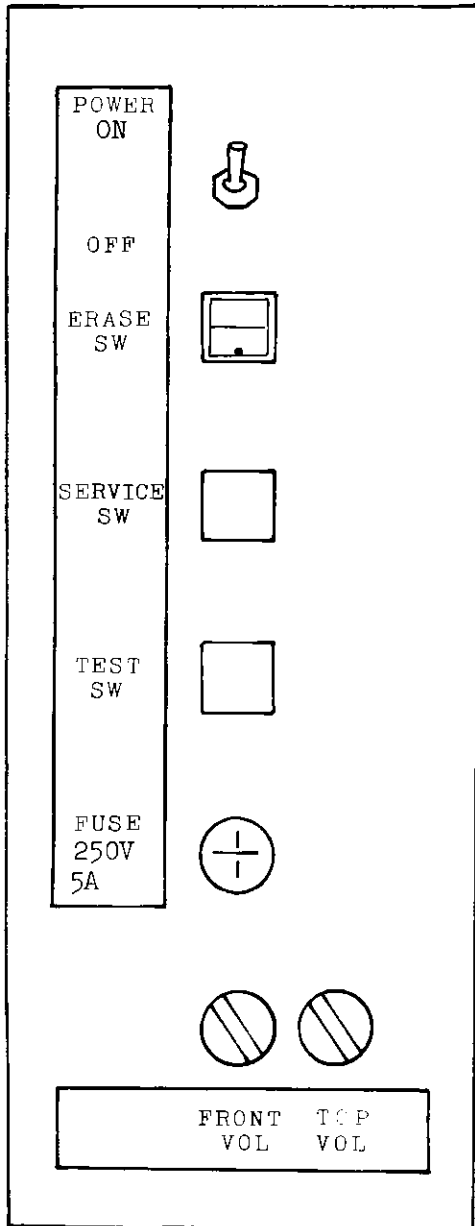

Power Switch

- For ON and OFF at main power source.
- Do not put COIN until demonstration pattern will appear, upon switching ON.

Erase Switch

- To use for eliminating magnetic field on CRT.

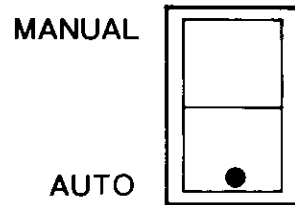

MANUAL POSITION

- MANUALLY DEMAGNETIZE CRT MONITOR WHEN UNIT IS BEING OPERATED, KEEP MANUAL POSITION FOR TEN MINUTE THEN TURN TO AUTO POSITION. (DO NOT MAINTAIN MANUAL POSITION)

AUTO POSITION

- AUTOMATICALLY DEMAGNETIZE CRT MONITOR WHEN POWER SWITCH ON. (NORMAL USE)

Service Switch

- To display Credit instead of Counter.

Test Switch

- For self testing (to refer corresponding item).

Fuse

- Be sure to use 5 A fuse (Ref. No. 1790382).

Volume

- To adjust sound volume from the speakers at each Front and Top.

7. Installation of Laser Disc Player

Laser disc player has to be so insulated from vibration, dusts and magnetic field that it is packed separately from the game machine. Please take following procedure to fit on the machine.

- 1) Dismantle the maintenance door of the machine by unlocking.

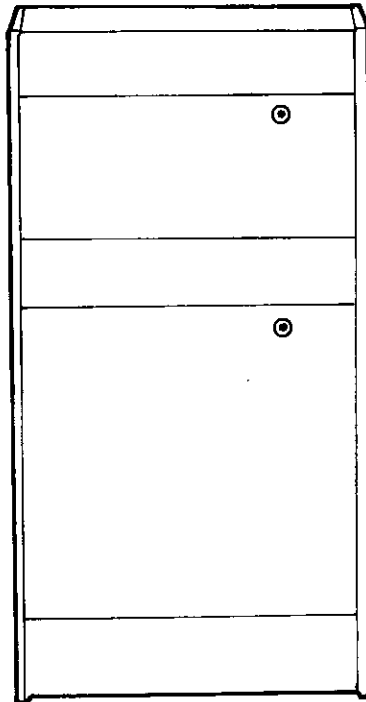

- 2) Pull back the board by pressing down the stopper positioning at the right side of the laser disc player board.

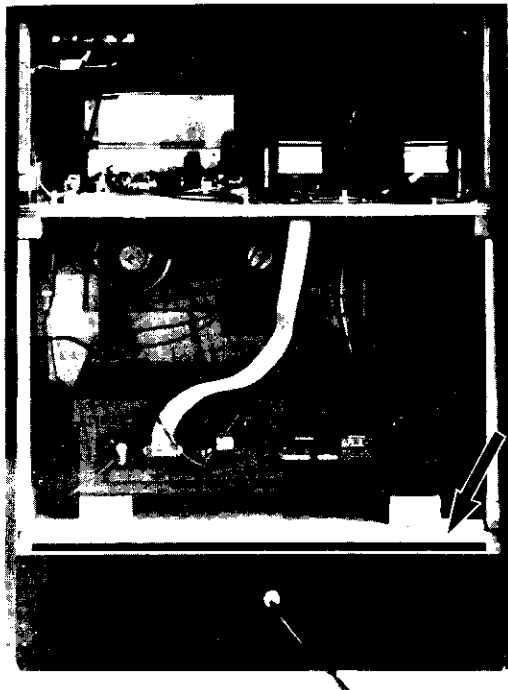

3) For opening the dust cover

- Plug the AC cord from the game machine into the AC socket.
- Plug the Laser disc player AC cord into "LASER DISC" socket on AC outlet terminal.
- Unlock the key upper side of the coin selector, and put POWER SW of the machine ON.
- Push ON the POWER A switch of Laser disc player, and the indication lamp will turn on.
- Push REJECT OPEN Button B, and push up the DUST COVER C by hand to open it.
(Unless power source is fed the dust cover will not open even pushing REJECT OPEN Button, then after opening it switch OFF power of the machine).

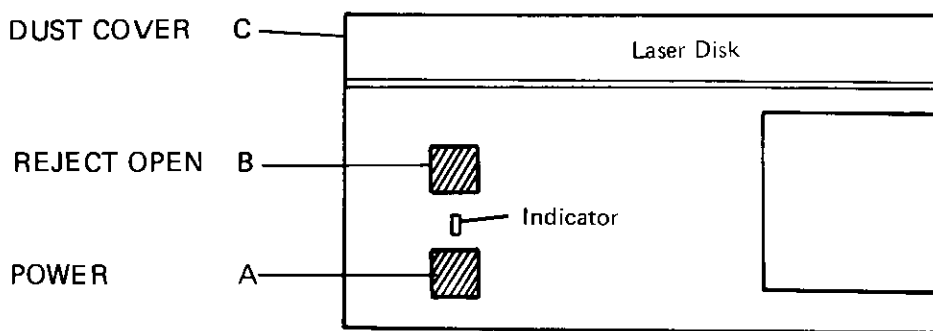

4) How to dismantle the fixing screw and lens cap

- In order to protect internal function during transportation, the fixing screw and lens cap are provided, which have to be dismantled and kept before setting the disc.

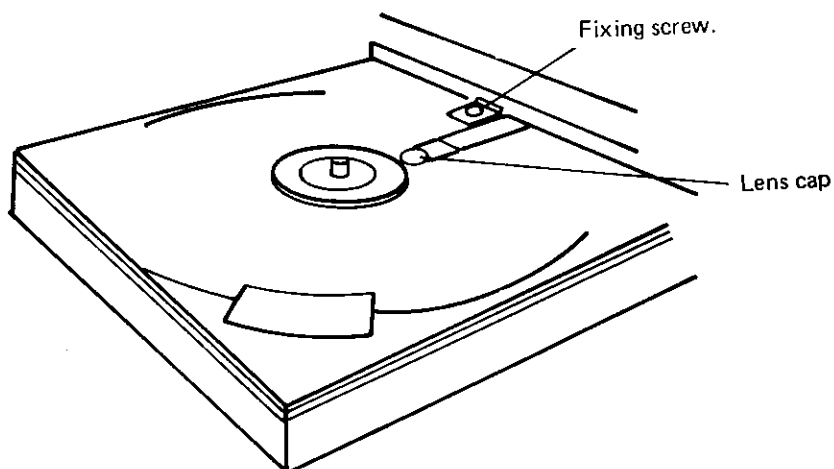

- To stop operation for long time and for transportation, please fix the screw and lens cap without fail.

5) How to fit the disc

- Set the laser disc, putting the label side downward, onto the spindle and close the dust cover.

- 6) Put Laser disc player on the laser disc board facing the connector side to the front (FIG. 1) and push it with the laser disc player board onto the extreme inside of the machine. Then check the board is certainly locked.

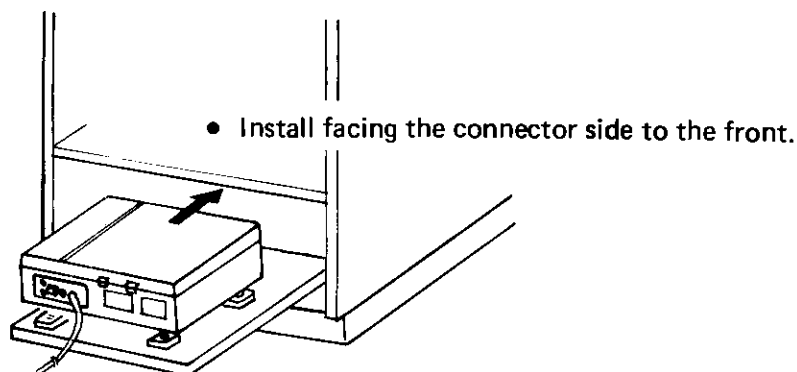

- 7) Connect each connectors of laser disc player as shown below and check if all the lead wires are connected, but handle carefully and gently.

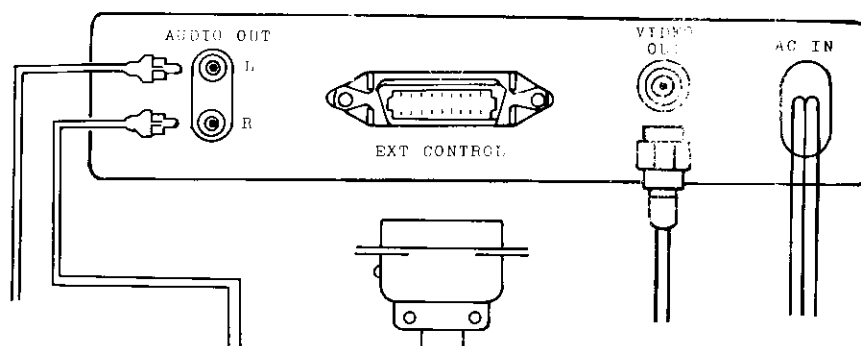

- **AUDIO OUT** — Sound power output terminal for Laser disc player (Identify pin-jacks, white for L and red for R)
- **EXT CONTROL** — The terminal to control Laser disc player through the game PC board.
- **VIDEO OUT** — Picture output terminal of Laser disc player
- **AC IN** — Power socket for AC 100 V. Be sure to plug in the socket inside of the box indicated as LASER DISC.

- 8) Great care must be paid for lead wires not be pulled to damage when taking Laser disc player in and out.

8. Self Test

This machine accommodate SELF TEST function, INPUT TEST, COLOR TEST and CRT POSITION TEST can be performed under the following procedure.

1. While pushing TEST SW on the control board inside of the coin selector, turn POWER SW ON, then INPUT TEST will be coming out on the screen as being indicated below, 2.
2. INPUT TEST
 - 1) Setting condition of Dip switch is indicated (to refer Dip switch table).
 - 2) Putting each switches indicated to ON, indication at the right side of the corresponding switches turn from 0 to 1, thus confirming normal switching function be done. (COIN 2 is not being used).
 - 3) Upon finishing INPUT TEST push TEST SW, then proceed to the next COLOR TEST.

INPUT TEST						
	1	2	3	4	5	6
DSW 1	0	0	0	0	0	0
DSW 2	0	0	0	0	0	0
FR RIGHT	0				COIN 1	0
FR LEFT	0				COIN 2	0
FLAP RIGHT	0	1		START		0
FLAP LEFT	0	2		START		0
FAZER						0
BURN						0

3. COLOR TEST

- 1) Avail it for color balance adjustment of CRT Monitor (to refer adjustment of CRT monitor).
(Do not adjust CRT Monitor when not required.)
- 2) When finishing COLOR TEST adjustment, push TEST SW, and proceed to the next CRT POSITION TEST.

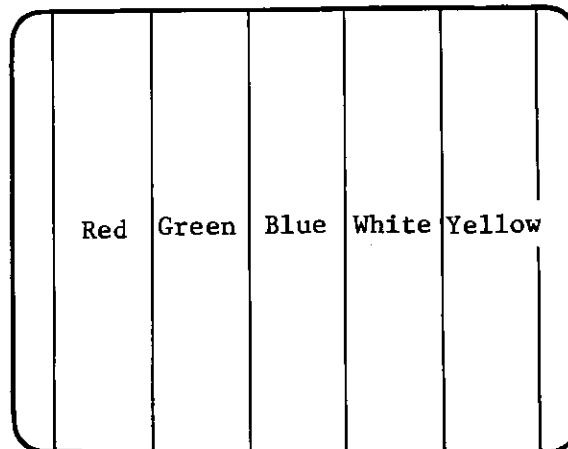

4. CRT POSITION TEST

- 1) Available to check linearity of CRT Monitor by CROSS HATCH (to refer CRT Monitor adjustment).
- 2) When CRT POSITION TEST is over, push TEST SW again.
- 3) STAND BY will be coming out on the screen, then, after a while, it will be back to game position.

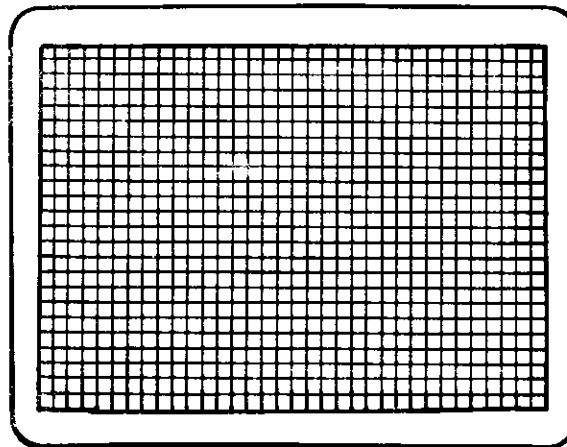

9. Adjustment of CRT Monitor

- Adjustment of CRT monitor is already done in the factory for the best condition, but slight trimming may be required depending on location.
- This machine contains super-impose circuit which composes NTSC signal from Laser disc player and RGB input signal of game machine PCB, so careless adjustment will cause disorder on synchronization, picture and color balance, if wrong adjustment is done.
- High voltage is loaded on CRT Monitor part, so please be carefull to adjust it.

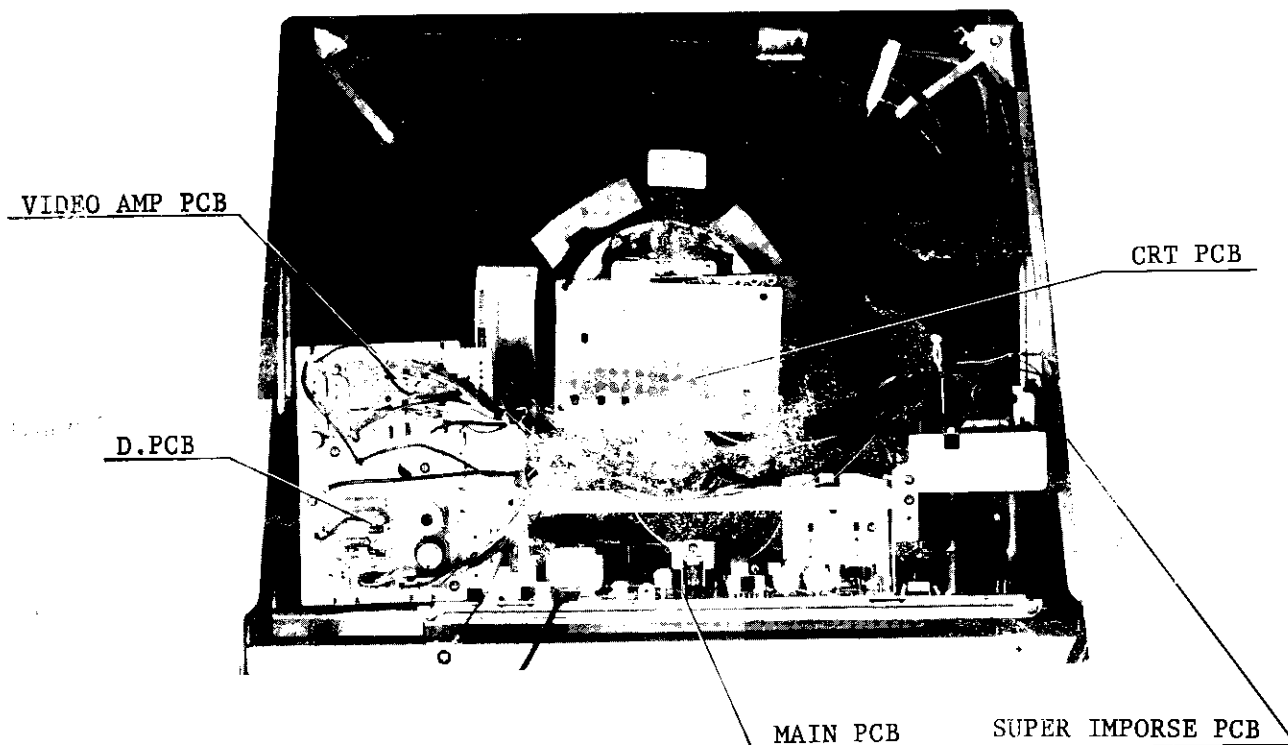

1. VIDEO AMP PRINT PCB (avoid to adjust normally)

BRIGHT (Potentiometer for brightness)

R.GAIN (Potentiometer for RED contrast)

G.GAIN (Potentiometer for GREEN contrast)

B.GAIN (Potentiometer for BLUE contrast)



2. D. PRINT PCB

H. POSITION (Potentiometer for Horizontal position)

V. POSITION (Change over to for Vertical position).
Depending on plug-in direction of the connectors, position will be different.

H. SIZE (Adjusting coil for Horizontal gain)



3. MAIN PRINT PCB

FOCUS (Potentiometer for focus)

+B ADJ (+B adjustment potentiometer)

SVC SW (Service switch)

V-HOLD (Potentiometer for Vertical synchronization)

V-SIZE (Potentiometer for Horizontal gain)

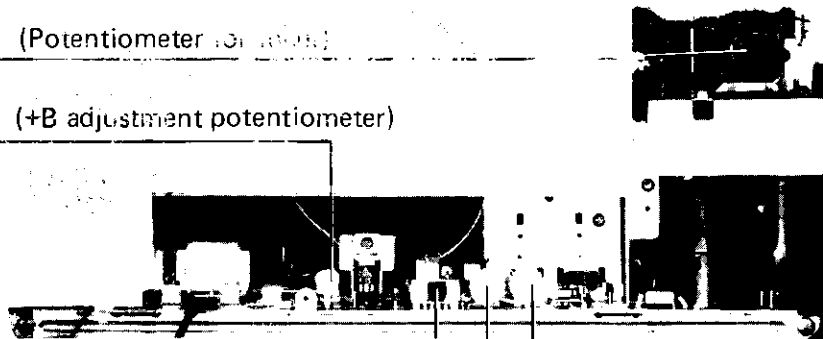

4. CRT Printed circuit board (not to adjust normally)

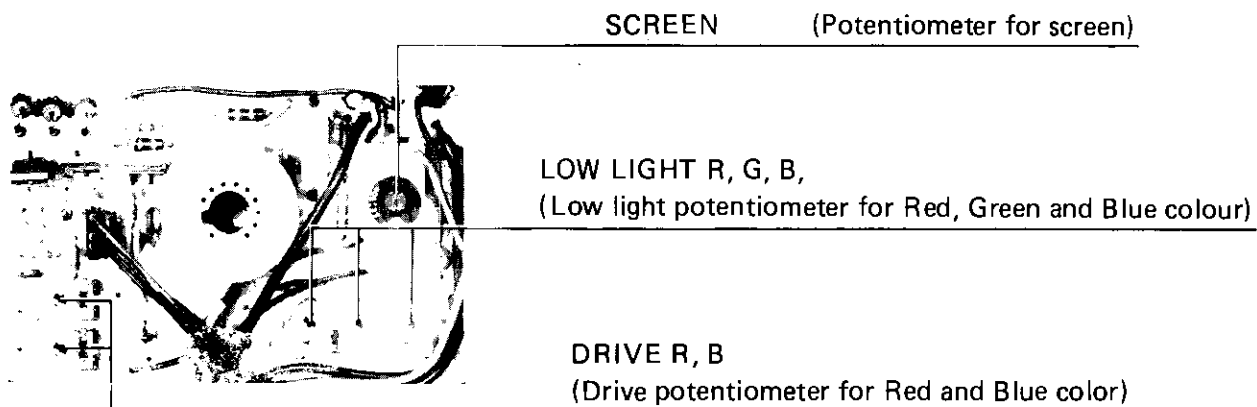

5. Super-impose printed circuit board (not to adjust normally)

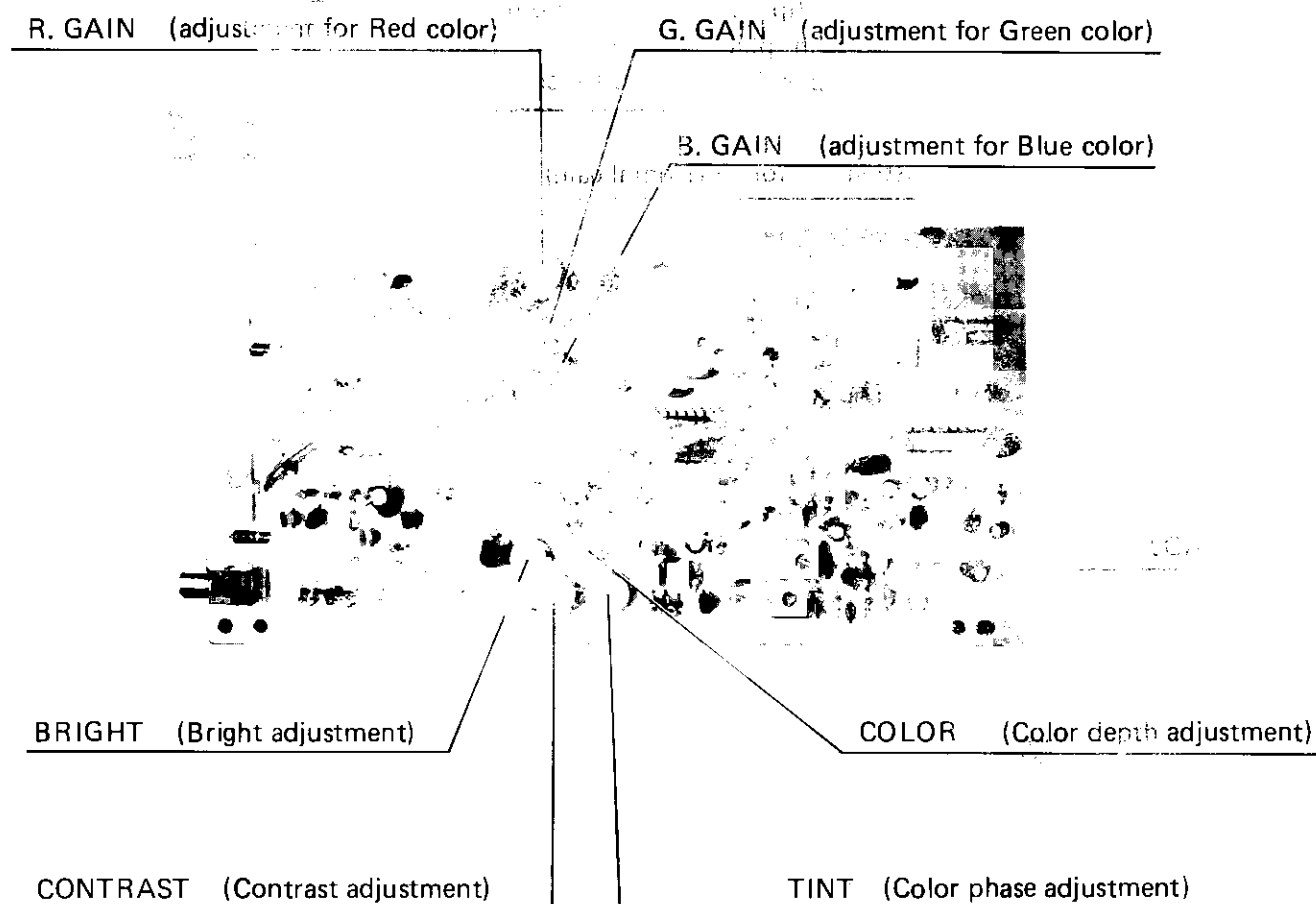

10. Dip Switch Table

(1) Location of the dip switch

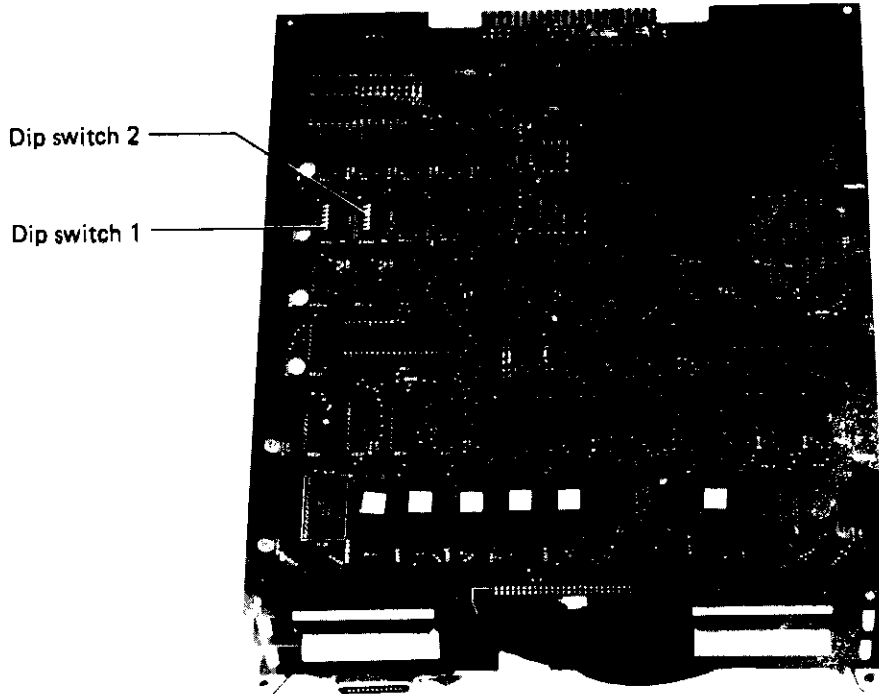

(Control PC. Board)

(2) Dip switch 1

Contents		SW					
		1	2	3	4	5	6
Demonstration sound FROM PC BOARD	Yes	ON					
	No	OFF					
Coin switch 1	1 coin/1 credit		OFF	OFF	OFF		
	1 coin/2 credit		OFF	OFF	ON		
	1 coin/3 credit		OFF	ON	OFF		
	1 coin/6 credit		OFF	ON	ON		
	2 coins/1 credit		ON	OFF	OFF		
	2 coins/3 credit		ON	ON	OFF		
No. of flights	3					OFF	OFF
	4					ON	OFF
	5					OFF	ON
	10					ON	ON

(3) Dip switch 2

In case of inter-stellar upright type the coin switch 2 is not used

Contents		SW	1	2	3	4	5	6
		YES	OFF					
Barrier UFO	YES	OFF					NOT USE	NOT USE
	NO	ON						
Coin switch 2	1 coin/1 credit			OFF	OFF	OFF		
	1 coin/2 credit			OFF	OFF	ON		
	1 coin/3 credit			OFF	ON	OFF		
	1 coin/6 credit			OFF	ON	ON		
	2 coins/1 credit			ON	OFF	OFF		
2 coins/3 credit			ON	ON	OFF			

11. Game Procedure

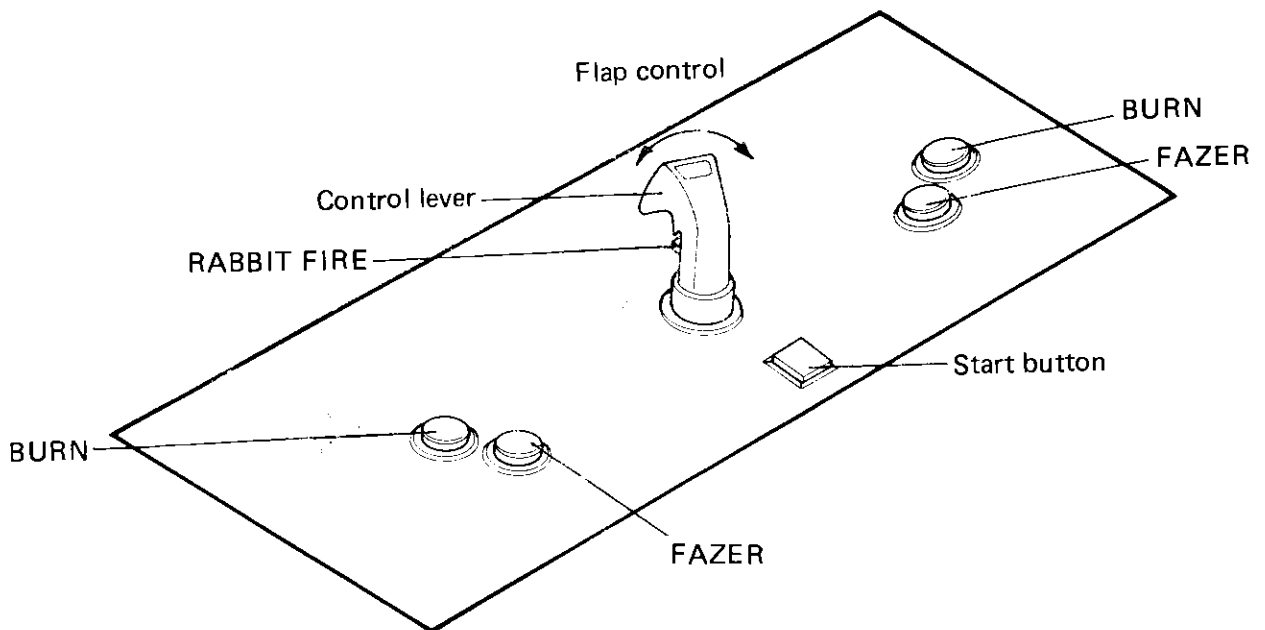

- 1) Game can be started upon pushing START button after putting in specified coin (available to change).
- 2) Move FRALD RANCER (Main character) to the right and to the left, and escape from enemy flights and attack.
- 3) Change direction of FRALD RANCER by flap control. and be prepared to attack them
- 4) FAZER and RABBIT FIRE are used to attack enemy flights for battle in the air.
- 5) Depending on screen MAIN computer "RABIT" will come down to the middle and be the target (+). At this moment, aim the target on the ground and attack by BURN. (When target (+) is not on the screen you can not attack by BURN).
- 6) As being mentioned above, escape from enemy flights, and at the same time attack and destroy enemy flights.

12. Cleaning of Filter

- Laser disc should not be dusted by any means.
Cleaning of filter must certainly be done once in fortnight.
Take out the maintenance door and detouch the filter positioned at the bottom, wash it out with water, then dry thoroughly in shadow.
For fixing it, please take care to eliminate gap.
Cleaning with chemical agent like Alcohol, Benzene and so on may damage the filter, it should be avoided absolutely.

Installation of Laser Disc Player

- 1) Dismantle the maintenance door of the machine by unlocking and unscrewing bolts.
Pull back the board by pressing down the stopper positioning at the right side of the laser disc player board.
- 2) For opening the dust cover
 - Plug the AC cord from the game machine into the AC socket.
 - Plug the Laser disc player AC cord into "LASER DISC" socket on AC outlet terminal.
 - Unlock the key upper side of the coin selector, and put POWER SW of the machine ON.
 - Push ON the POWER A switch of Laser disc player, and the indication lamp will turn on.
 - Push REJECT OPEN Button B, and push up the DUST COVER C by hand to open it. (Unless power source is fed the dust cover will not open even pushing REJECT OPEN Button, then after opening it switch OFF power of the machine).

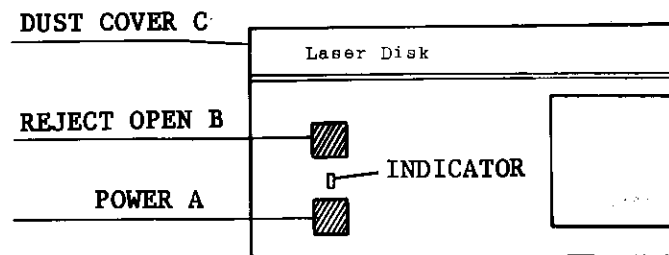

- 3) How to dismantle the fixing screw and lens cap
 - In order to protect internal function during transportation, the fixing screw and lens cap are provided, which have to be dismantled and kept before setting the disc.
 - To stop operation for long time and for transportation, please fix the screw and lens cap without fail.
- 4) How to fit the disc
 - Set the laser disc, putting the label side downward, onto the spindle and close the dust cover.

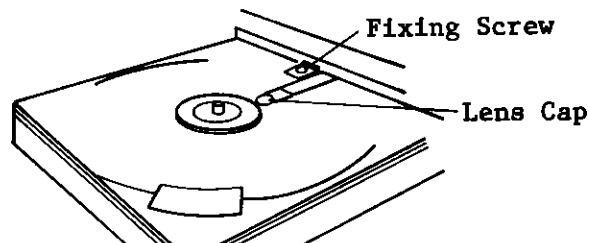

- 5) Put Laser disc player on the laser disc board facing the connector side to the front and push it with the laser disc player board onto the extreme inside of the machine. Then check the board is certainly locked.
- 6) Connect each connectors of laser disc player as shown below and check if all the lead wires are connected, but handle carefully and gently.

