

# **namco®**

## **FINAL LAP™ 3 UPRIGHT Operators Manual**

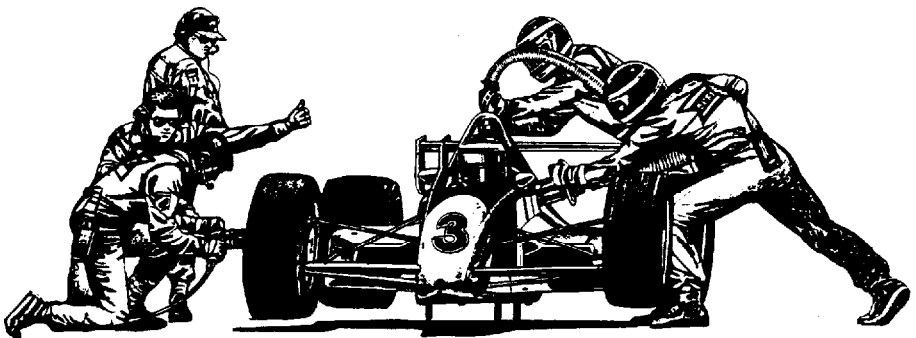

© 1992 NAMCO-AMERICA, INC. ■ All rights reserved.

No **part** of this publication may be reproduced by any mechanical, photographic or electronic process, or in the form of a phonographic recording, nor may it be stored in a retrieval system, transmitted, or otherwise copied for public or private use, without permission from NAMCO-AMERICA, INC.

Published by:  
NAMCO-AMERICA, INC.  
3255-I Scott Blvd., Suite 102  
Santa Clara, CA 95054-3013  
TEL: (408)496-6371  
FAX: (408)496-6399

Printed in the U.S.A.

# CONTENTS

1. SPECIFICATIONS..	1
2. PRECAUTIONS	
2-1 Caution When Installing..	1
2-2 Caution When Handling ..	2
3. INSPECTION ..	2
4. INSTALLATION	
4-1 Installing Game Cabinet .....	3
4-2 Preparing the Game for Operation .....	4
4-3 Connecting Two or More Games Together .....	4
4-4 Power On/Off Switch Location.....	5
<b>4-5</b> Choosing the Car Color .....	6
5. ADJUSTMENTS	
<b>5-1</b> Power On .....	6
<b>5-2</b> Adjustment Switches on the Service Panel .....	6
<b>5-3</b> Test Mode and Play Options .....	7
<b>5-3-(3)-2</b> Bookkeeping for FINAL LAP 3 .....	10
S-4 Monitor Adjustments .....	10
<b>5-5</b> <b>Initializing Controls</b> .....	11
6. HOW TO PLAY .....	12
7. MAINTENANCE	
<b>7-1</b> Opening the Control Panel .....	13
7-1-1 <b>Shift</b> Assembly.....	13
7-1-2 Steering Assembly.....	14
7-1-3 Steering Potentiometer.....	14
<b>7-2</b> Gas Pedal Assembly .....	15
<b>7-3</b> <b>Removing the Game PCB</b> .....	15
7-4 Removing the Monitor .....	16
7-5 Replacing the Speakers .....	16
<b>7-6</b> <b>Replacing the Fluorescent Attract Lamp</b> .....	16
8. TROUBLESHOOTING – GENERAL .....	17
8-1 Troubleshooting – Power Up .....	18
9. PARTS LIST .....	21
10. GAME HARNESS WIRING DIAGRAMS .....	25
11. LIST OF ILLUSTRATIONS (See over)	

## 11. LIST OF ILLUSTRATIONS

4-1 <b>3/4</b> Front and Back View of Game .....	3
4-2 Link Connection ■ One Cabinet .....	4
4-3 Link Connection ■ Two to up to Eight Cabinets .....	5
4-4 Car-Color Connectors .....	6
<b>5-1</b> Service Panel .....	7
5-2 Game Option Screen .....	8
5-3 Table of Game Option Settings .....	8
5-4 Switch Test Screen .....	9
5-5 Monitor Remote Adjustment Board .....	<b>10</b>
5-6 Switch Test Screen ■ (Initialize Completed) .....	<b>11</b>
7-1 Opening the Control Panel .....	13
7-2 Shift Assembly .....	13
7-3 Steering Assembly .....	14
7-4 Steering Potentiometer .....	14
7-5 Gas Pedal Assembly .....	15
7-6 Replacing Game PCB .....	15
7-7 Replacing the Monitor.. .....	<b>16</b>
7-8 Replacing Speakers/Fluorescent Lamp .....	16

# FINAL LAP™ 3 UPRIGHT

## 1. SPECIFICATIONS

POWER SUPPLY:	PC XT Type Switching Power Supply		
POWER CONSUMPTION:	Not to exceed 150W, 120VAC, 1.0 AMP		
DIMENSIONS:	Width	Depth	Height
	28 1/2"	30 1/4"	74"
CRATED DIMENSIONS:	Width	Depth	Height
Monitor Cabinet Carton	29"	37"	77"
SHIPPING WEIGHT:	325 lbs.		
MONITORS :	One (1) standard 25" Color Monitor with auto degause and remote adjustment board		
ACCESSORIES:	Keys: (Coin Box) ..... 2 (Coin Door) ..... 2 (Rear Door) ..... 2 Security Wrench ..... 1 Link Cable ..... 1 Instruction Manual ..... 1 Operators Quick Reference Card ..... 1		

Note: Specifications may change without prior notice. Modification and/or alteration of the FINAL LAP 3™ game with kits or parts not supplied by NAMCO may void the warranty.

## 2. PRECAUTIONS

### 2-1 Caution when installing

This game is designed for indoor use only. The game must not be installed outdoors or under the following conditions:

- a. In areas directly exposed to sunlight, high humidity, direct water contact, dust, high heat or extreme cold.
- b. In locations that would present an obstacle in case of emergency, i.e. near fire equipment or emergency exits.
- c. On an unstable surface or subject to floor or other vibration.

## 2-2 Caution when handling

- a. Power must always be turned off before replacing any parts or connecting/disconnecting the connectors.
- b. Do not subject game to physical shock when transporting or moving it.
- c. The power supply range is between 1 10-120V AC.
- d. The cabinet must be grounded with a securely connected ground plug.
- e. Care must be taken at all times to avoid electrical shock whenever inspecting or adjusting the game.
- f. When unplugging the game from an electrical outlet, grasp the plug, not the cord.
- g. DO NOT attempt to repair the Printed Circuit Board (PCB) on site. It contains sensitive chips that could easily be damaged by even the small internal voltage of a multi-meter. Always return the PCB to your distributor for any repairs.

## 3. INSPECTION

The FINAL LAP 3 Game carton should be carefully inspected upon receipt to insure that the game is complete and was delivered in good condition.

Inspect the game cabinet by doing the following:

1. Examine the cabinet exterior for dents, chips, or broken parts.
2. Unlock and open the rear service door, the front coin door, and the front dash panel (unbolt 3 bolts) that swings forward and down.

Inspect the interior of the cabinet as follows:

- a. Verify that all plug-in connectors (on the cabinet harnesses) are fiy plugged in. The connectors next to the PCB metal enclosure are for the car-color selection. Any or none of the three connectors can be plugged into the harness connector. (For more information, Ref. 4-5, Choosing the Car-Color). DO NOT force connectors together. The connectors are keyed so they fit only in the proper orientation. A reversed edge connector can damage a PCB and will void your warranty.
- b. Inspect the power cord to insure that there are no cuts or dents in the insulation.
- c. Inspect the power supply connectors.
- d. Inspect other major sub-assemblies, such as the video display monitors, PCBs, and speakers. Make sure that they are mounted securely and that all ground wires are fiy connected.

## 4. INSTALLATION

### 4-1 Installing Game Cabinet

- a. Each Cabinet has two casters (one on each rear comer) and a Moving Assist Handle located on the upper portion of the cabinet back to allow for easy roll-in and positioning of the game.
- b. Tilt and roll the cabinet near to its intended operating position, and lower the four (4) leg levelers, one on each comer of the cabinet, until the game rests firmly on the floor.
- c. **Note** that the cabinet design provides for front servicing through the “swing-down” Control Panel illustrated below. This provides front access to the Monitor Adjustment Board, the game PCB, and the Steering and Shift Assemblies. This eliminates the need for the technician to move the game away from the wall to service these components.
- d. Remove the three (3) security bolts on the top edge of the Control Panel, and carefully (its heavy) swing it down on its hinge to open.

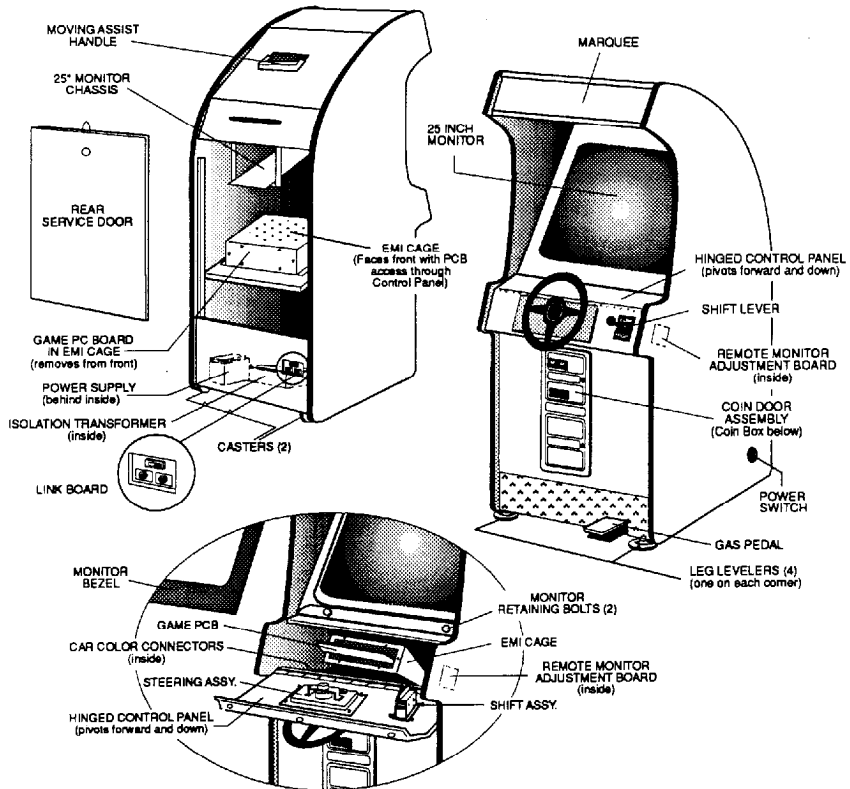

Illustration 4-1, 3/4 FRONT and BACK VIEW OF GAME

#### 4-2 Preparing the game for operation

If installing a single **player** FINAL LAP 3 unit, check the following:

- a. Be sure all power is disconnected before making any adjustments.
- b. Remove the monitor AC power cord, and plug it into the power supply.
- c. Note the position of the Link PCB Switch located in the recessed metal box opposite the power supply on the lower back panel of each Monitor Cabinet.
- d. Each FINAL LAP 3 is shipped with the connector switch set for a single cabinet operation, and should have the slide switch set in the "OUT" position. Check to make sure it is set to "OUT" (see below).

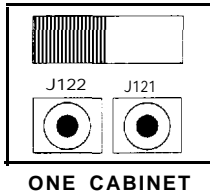

Illustration 4-2, LINK CONNECTION ONE CABINET

#### 4-3 Connecting two (2) or more FINAL LAP 3s

Up to eight (8) FINAL LAP 3s can be interconnected (linked) to allow up to eight (8) players to participate in the same race. When linking two or more games, the following conditions must be met:

- a. Each FINAL LAP 3 game should be connected to a separate power outlet.
- b. Game difficulty and lap settings must be the same on all monitors in the linked group. (Ref. 5-3-(2))
- c. All connecting slide switches should be set to the "IN" setting.
- d. Install the link cables between the FINAL LAP 3s by connecting an "OUT" from one Monitor Cabinet to an "IN" of another game per the following diagrams. Be sure to seat each plug solidly in its jack.
- e. Perform the self-test by turning the power on to each game. Make sure that the connections are properly made between games. (Ref. 5-3-1, Self-Test)



(CAUTION)

- \* Make the Link Cable as short as possible to insure best signal transmission.
- \* Link Cables transmit electronic data between games and are subject to electronic interference.
- \* Install the Link Cable as far from other room cables as possible.

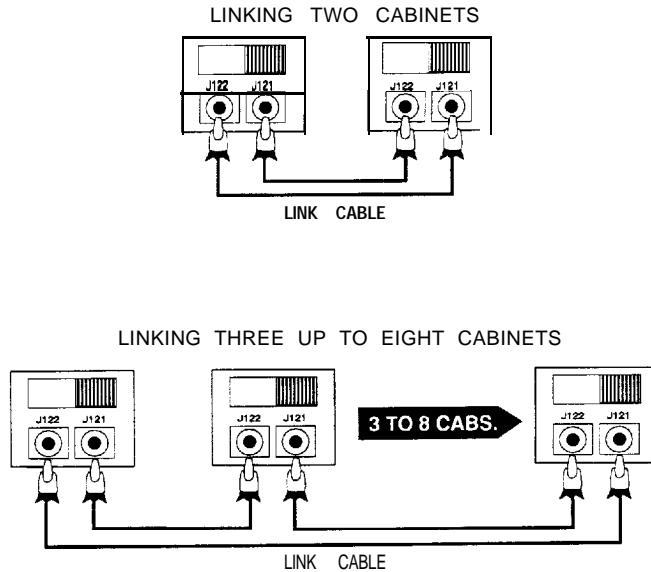

Illustration 4-3, LINK CONNECTIONS - 2 to UP TO 8 CABINETS

4-4 Power On/Off Switch location

The power supply is located inside the back of the cabinet and accessed through the Rear Service Door.

The on/off switch is accessed through an opening on the lower right rear side (as you face the game) of the cabinet.

## 4 5 Choosing the car color

Each player can select from one of four car colors. This is done by plugging in different connectors (included with the game) into the car-color connector located on the cabinet wall by the PCB enclosures, and accessed through the Front Control Panel

The game, as shipped, has one connector plugged into the car-color harness and the other two connectors attached to it.

The following are the car colors and their connectors:

- Light blue car. Plug in the connector with wires at all 4 pins.
- Blue and white car. Plug in the connector with wires at pins 2 and 4.
- Yellow car. Use NO connector.
- Red car. Plug in the connector with wires at pins 1 and 3.

**YELLOW Car = USE NO CONNECTOR**

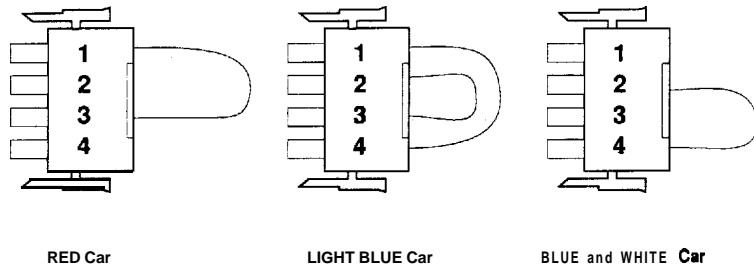

Illustration 4-4, CAR-COLOR CONNECTORS

## 5. ADJUSTMENTS

### 5-1 Power on

When installation is complete, connect power cord to outlet and turn power on. (Ref. 4-4 = Power on/off Switch location)

### 5-2 Adjustment switches on the Service Panel

There are switches on the Service Panel located inside the coin door for adjustment of the speaker volume, and for accessing the test mode.

(1) Test Switch

Turning this switch "ON" enters the test mode, and activates the Game Option Screen on the Player Monitor. This is where the self-tests are performed, and game variables (pricing, level of difficulty, number of laps per game etc.) are set/changed (Ref. 5-3-(2)). Turn the test switch to the "OFF" position at any time to return to The Game Screen.

(2) Sound Volume Control

Stereo left and right sound volume **adjustment** is made separately for left/right speakers located behind the marquee panel.

(3) Credit Switch

By pressing this switch, the number of credits can be increased without advancing the coin counter.

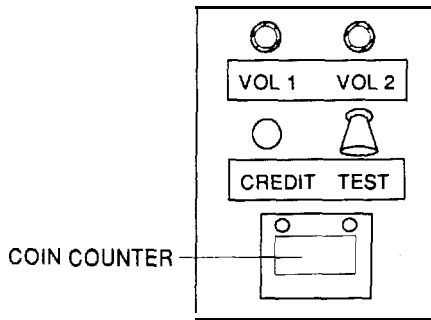

Illustration 5-1, SERVICE PANEL

5-3 Test Mode

The self-test function is activated by using the test switch. There are five (5) kinds of test mode screens where the game pricing is changed and where various tests for each control are performed.

(1) Self-test

Open the coin door and flip the test switch to the "ON" position. If the game Printed Circuit Board is operating properly, the "Game Option Screen" is displayed on the monitor. Pressing the credit switch while in the Game Option Screen causes the various Test Screens 1 through 5 (Switch Test Mode Screen, ADS (Bookkeeping) Mode Screen, Cross Hatch Pattern (2) and Color Bar Test Screen) to appear. (Ref. 5-3-(3), "Test Mode Screens", for information regarding each screen).

(2) Changing the game settings (Game Option Screen)

Turning the Test Switch “ON” displays the Game Option Screen, allowing game pricing and other settings to be changed.

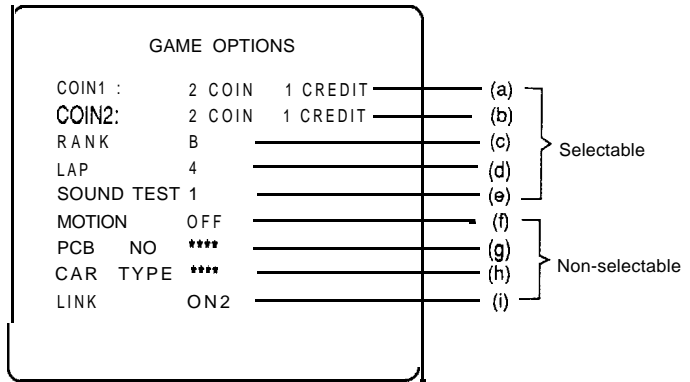

Illustration 5-2, GAME OPTION SCREEN

Select an item to be changed by turning the steering wheel until the desired item is illuminated in red letters. To change the content of the selected item, shift gears to “HIGH”. Select the settings according to the TABLE OF GAME OPTION SETTINGS (below). After all desired changes have been made, press the Credit Switch, and various test screens will appear in sequence EACH TIME THE CREDIT SWITCH IS TOGGLED.

TABLE OF GAME OPTION SETTINGS (4 standard setting)

ITEM	CONTENT	
	(a) Game Fees (tin 1)	Coin(s)
Credit(s)		1-9 (original setting is 1 a )
(b) Game Fees (coin 2)	Coin(s)	1-9 (original setting is 2 < )
	Credit(s)	1-9 (original setting is 1 < )
(c) Rank (game difficulty)	A (easy) D (difficult) (original setting is Ba )	
(d) Lap	3 6 (original setting is 4 < )	
( e ) Sound Test	Various sound affects can be tested.	
(f) Motion	This should always be OFF. (unchangeable)	
(g) PCB = NO.	OK when it is shown.	
(h) Type of My Car	OK when it is shown.	
(i) Communication function test	Normal when it is ON. The number of game machines connected is indicated.	

Illustration 5-3, TABLE OF GAME OPTION SETTINGS

### (3) Test Mode Screens

#### 1. Switch Test Screen

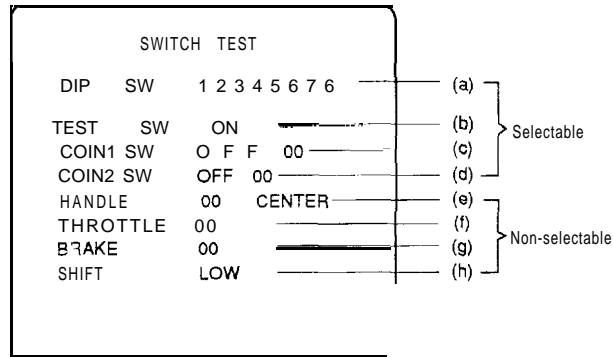

Illustration 5-4, SWITCH TEST SCREEN

- (a) The status of the option switches on the game PCB (CPU-PCB) is indicated by this display. Any number opposite DIP SW (switch) that is lighted red indicates that it is turned on.
- (b) A lighted red "ON" opposite TEST SW (switch) indicates a normal condition.
- (c) When the coin 1 switch is closed, a lighted red "ON" appears indicating proper operation. The number displayed indicates the number of times the switch has been triggered. The coin counter will also advance.
- (d) When the coin 2 switch is closed, a lighted red "ON" appears indicating proper operation. The number displayed indicates the number of times the switch has been triggered. The coin counter will also advance.
- (e) Under normal conditions, the following displays result from operating the steering wheel.
  - 1) "00 CENTER" is shown with hands off the steering wheel.
  - 2) When the wheel is turned to the left, the word "LEFT" and decreasing numbers indicating degree of turn are shown.
  - 3) When the wheel is turned to the right, the word "RIGHT" and increasing numbers indicating degree of turn are shown.
- (f) Pressing the gas pedal down gradually increases the number and "OK" will be displayed if all is normal. "00" should be displayed when the pedal is not depressed.
- (g) The Upright version of FINAL LAP 3 does not use a brake function or a brake pedal.
- (h) Moving the position of the shift lever from High to Low should produce a matching "HIGH" or "LOW" display indicating normal operation.

2. ADS Mode Screen (Bookkeeping for **FINAL LAP** 3)

The ADS screen denotes the four race tracks individually. The ADS keeps count of the number of times the particular track was selected and played, and the number of laps completed on that track. This provides an operator the ability to keep track of the most played **tracks**. To clear the system (reset count to all o's) shift gears from **LOW** to **HIGH**. The "ADS CLEAR?" question should read "YES". Exiting the test screen will reset all the counters.

3. Cross Hatch Pattern Screen, (Ref. 541)

4. Cross Hatch Pattern Screen with White Block Adjustment. (Ref. 542)

5. Color Bar Test Screen. (Ref. 543)

### 5-4 Monitor Adjustments

The monitor remote adjustment control is located behind the control panel on the right front of the cabinet side wall, and is accessed by opening the control panel.

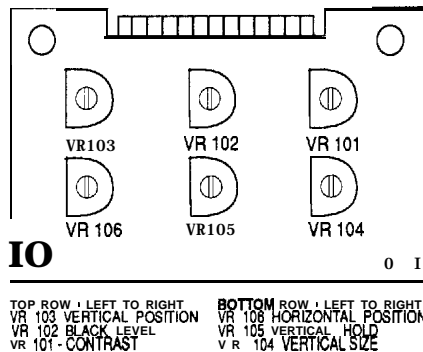

Illustration 5-5, MONITOR REMOTE ADJUSTMENT BOARD

#### 541 Cross Hatch Pattern

To center cross hatch pattern:

- Use VR 103 (V-POS) to adjust cross hatch UP or DOWN.
- Use VR 106 (**H-POS**) to adjust cross hatch LEFT or RIGHT.

#### 542 Cross Hatch Pattern with White Block Adjust

White block adjustment should not be necessary – just insure that block is centered in the cross hatch, and is white. If it is not, call a qualified Service Technician.

### 543 Color Bar Test

#### **WARNING - HIGH VOLTAGE**

Color should not need adjusting, but if the white fade test (the bottom white bar) is tinted an off color, adjustment can be made with the appropriate color gun adjustment on the CRT neck board, i.e. RED – VR202, GREEN – VR204, BLUE – VR206, or by a qualified Service Technician.

## 5-5 INITIALIZING CONTROLS

When replacing the game PCB, the ROM, the Steering Assembly, the Gas Pedal Assembly, or the potentiometer, be sure to follow the procedures below.

- (1) Open the coin door.
- (2) Remove hands and feet from the steering wheel and the gas pedal.
- (3) While in the game screen, hold the credit switch and turn the test switch on at the same time.
- (4) "INITIALIZE COMPLETED" will be shown on the monitor display (see below), and the adjustment is finished.
- (5) Turn the test switch "OFF" to return to the game screen.

SWITCH TEST						
DIP	SW	1	2	3	4	5 6 7 6
TEST	SW	ON				
COIN1	SW	OFF	00			
COIN2	SW	OFF	00			
HANDLE		00	CENTER			
THROTTLE		00				
BRAKE		00				
SHIFT		LOW				
INITIALIZE		COMPLETED				

Illustration 5-6, SWITCH TEST SCREEN

## 6. HOW TO PLAY

- FINAL LAP 3 Upright is a race game that allows one to eight players to compete against time and/or each other. Eight separate games can be connected, and up to eight (8) players can race simultaneously.
- Each player manipulates his/her car independently by using the steering wheel, gas pedal, and shifter, trying to cross the finish line first while staying within the course and avoiding a crash with opponents vehicles and/or computer-controlled cars.
- After inserting the proper coin(s), a player starts the game by stepping on a pedal.
- Once a player starts a game, he/she is asked to select a course to race on. Screens on other linked idle cabinets display a message urging others to enter. Additional players can enter the race by inserting the proper coin(s) and depressing a pedal within 15 seconds. If a race has already begun, others can enter and enjoy another race together. One person can always play if no others enter that particular race.
- FINAL LAP 3 offers four (4) different race courses from which players select one for each race. A player has 1.5 seconds to select a course by turning the steering wheel, and confirm their selection by stepping on a pedal. If players select different courses, one course is decided by majority vote. In the event of a tie, one of the selected courses is randomly chosen by the computer.
- Once all the players have selected their courses, or if 15 seconds passes, the timer counts down to “3-2-1” and the race starts with a “GO” sign.
- The race continues until the timer runs out. The **first** player to complete a lap will extend the game time for all players in the same race.
- After completing the preset number of laps (operator adjustable), players reach the finish line and the thrill of the checkered flag.
- When players reach the finish line or time runs out, racing statistics, including the player’s ranking and lap times, are shown.
- When a player wins a race in which two or more persons are entered, a Championship Celebration is shown on the monitor.
- Players can enter their scores with their initials onto the screen by using the steering wheel and stepping on the gas pedal to set.
- Any initials entered are reset once the game’s power is turned off.







- (1) Open Control Panel by removing three (3) screws.
- (2) Remove the two (2) screws that hold the potentiometer brackets.
- (3) Take out the entire potentiometer bracket including the gear.
  - NOTE: \* Since the potentiometer has a built-in stop, be sure that the stop won't over travel when reassembled.
  - \* When replacing, set the potentiometer to have a value of 2.5K  $\Omega$  (mid range).
  - \* When the potentiometer and the Steering Assembly are replaced, initialization is required. (Ref. 5-5)

## 7-2 HAPP CONTROLS Gas Pedal Assembly

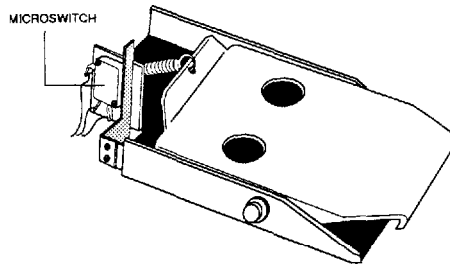

Illustration 7-5, GAS PEDAL ASSEMBLY

- (1) Open the rear door and remove the connector to the pedal assembly.
- (2) The Pedal Assembly may now be accessed from the back for removal.
- (3) Remove the three (3) screws that secure the pedal assembly to the cabinet, then the pedal assembly can be taken out from the back.

## 7-3 Removing the game PCB

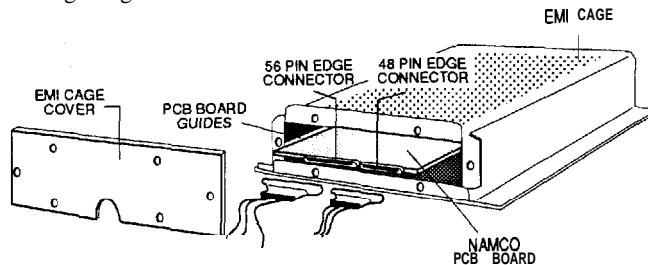

Illustration 7-6, REPLACING GAME PCB

- (1) Turn the game power **OFF**.
- (2) Open the Control Panel. (Ref. 7-1)
- (3) Remove six (6) screws that hold the steel end panel on the EMI Cage.
- (4) Carefully remove all the connectors from the game PCB to be taken out.
- (5) Carefully slide out the game PCB to remove.

#### 7-4 Removing the Monitor

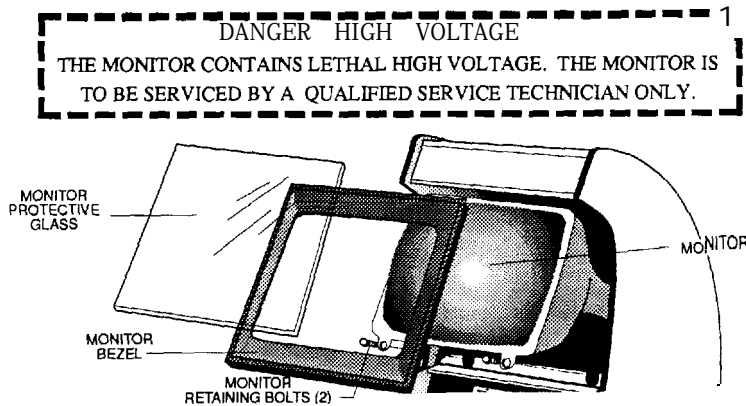

Illustration 7-7, REPLACING the MONITOR

- (1) Turn the game power **OFF**.
- (2) Open the back Service Door.
- (3) Disconnect the monitor from the main harness.
- (4) Disconnect the monitor from the Remote Monitor Adjustment PCB harness.
- (5) Working from the front, remove the protective glass and the plastic monitor bezel and set them carefully aside.
- (6) Remove the two (2) bolts securing the lower metal edge of the monitor chassis to the cabinet. (Ref. Illustration 7-1)
- (7) Lift the monitor UP and OUT of the front of the cabinet.

#### 7-5 Replacing the speakers

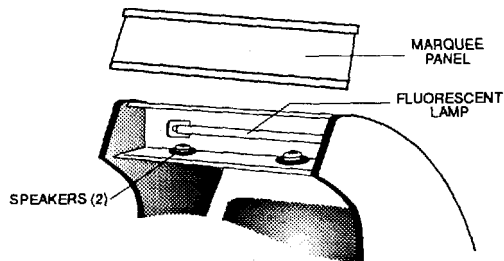

Illustration 7-8, REPLACING SPEAKERS/ FLUORESCENT LAMP

- (1) Remove the marquee panel.
- (2) Remove the speaker connectors.
- (3) Remove the nuts retaining the speakers.

#### 7-6 Replacing the fluorescent lamp/starter

- (1) Remove the marquee panel.
- (2) Remove and replace the fluorescent lamp or the starter.

## 8. TROUBLESHOOTING ■ GENERAL

If you suspect the game may be malfunctioning, the following steps should be taken before you make a service request.

- (1) The power supply should be between 110-120 Volts AC. However, when some other equipment (air conditioner, multiple pinball games, air compressors, etc.) are connected to the same power supply, the voltage may change beyond this range and cause game trouble or improper operation. Each cabinet should have its own dedicated power source.
- (2) When the game does not work with the power turned on, turn the power off once and then back on. This may restart the game. If it still does not work, inspect the fuses. (Ref. XX Power Control Panel Assy.)
- (3) When the game PCB, the ROMs, the Steering Assembly, the Gas Pedal Assembly, or the Potentiometers are replaced, it is necessary to make adjustment to play normal games. Make appropriate adjustments referring to 5-5, Adjustment when replacing the parts ■ Initialization.
- (4) Check all wiring connections as malfunctions can be caused by loose connections.
- (5) Foreign substances on the game PCB or on the monitor PCB, or dust may cause malfunctions or improper operation. Check that the PCBs are clean.
- (6) When you make electrical checks, use the wiring diagrams for reference.
  - \* If the above suggestions are not applicable, or no improvement is observed, contact your distributor or the service office printed on the back cover of this manual.
  - \* DO NOT ATTEMPT TO REPAIR THE GAME PCB YOURSELF. Instead, please return the board to your distributor for any repairs. This PCB contains sensitive chips that could be destroyed even by the internal voltage of a multi-meter.
  - \* When sending parts to be repaired, make sure to pack them firmly with a complete explanation of the problem. When sending PCBs, package them in anti-static foam or bubble wrap, and pack them in cardboard boxes to protect against impact damage during shipment. To ship monitors, pack them in wooden frames so that CRTs and PCBs are protected against excess load.

## 8-1 TROUBLESHOOTING - POWER UP

SYMPTOM	RELATIVE PROBLEM	SOLUTION
NO POWER  (Check that game is plugged in)	BLOWN FUSE	CHECK FUSE ON POWER SUPPLY AND REPLACE IF NEEDED
	POWER SWITCH NOT FUNCTIONING	VERIFY THAT SWITCH IS ON AND NOT BROKEN.
	OPEN CIRCUIT	VERIFY PLUG IS SECURELY MATED TO MACHINE.
	BAD POWER SUPPLY	WITH A VOLTMETER, CHECK TO INSURE 110 VOLT INPUT TO P/S AND ALL APPROPRIATE VOLTAGES ARE BEING OUTPUT REPLACE P/S IF NEEDED.

POWER ON • NO VIDEO	POWER SUPPLY VOLTAGE	VERIFY FAN IS RUNNING AND APPROPRIATE VOLTAGE IS GOING TO CRT. IF SO, THEN CHECK FUSE ON CRT VIDEO CARD AND REPLACE IF NEEDED.
	NO RASTER or RASTER-NO VIDEO	VERIFY ALL CONNECTORS ARE ON AND SECURE.  VERIFY VIDEO CONNECTOR TO CRT VIDEO CARD IS ON CORRECTLY.  VERIFY POWER CONNECTOR TO CRT IS SECURE, AND CHECK THAT VOLTAGE TO CRT IS 110-117 VOLTS
	BAD or OFF-CENTER PICTURE	REFER TO SECTION 5-4 FOR ADJUSTMENTS.

8-1 TROUBLESHOOTING - POWER UP (Cont.)

SYMPTOM	RELATIVE PROBLEM	SOLUTION
<p><b>POWER ON- NO AUDIO</b></p>	<p>BAD VOLUME CONTROL</p>	<p>CHECK VOLUME CONTROL ON SERVICE PANEL. IF NO VOLUME. CHECK POTENTIOMETER WITH AN OHM METER</p> <p>VERIFY CONNECTORS ARE ON AND SECURE.</p>
	<p>BOARD POTENTIOMETER</p>	<p>CHECK VOLUME RESISTOR ON PCB SET AND ADJUST.</p> <p>CHECK AND INSURE THAT THERE IS A JUMPER IN THE STEREO POSITION OF J 1.</p>

<p><b>NO CONTROL RESPONSE</b></p>	<p>NO CAR MOVEMENT OR ACCELERATION</p>	<p>VERIFY ALL CONNECTORS ARE ON AND SECURE.</p> <p>CALL SERVICE TECHNICIAN.</p>
---------------------------------------	--	---

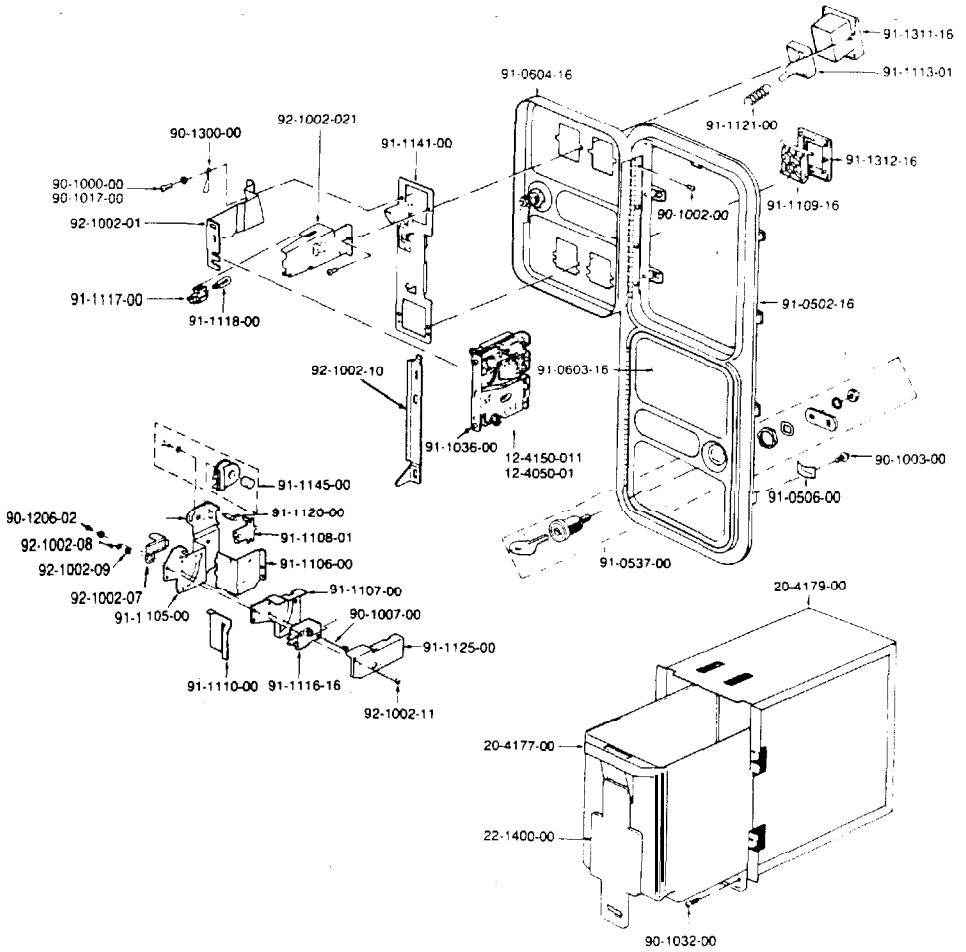

COIN CONTROLS COIN DOOR ASSEMBLY



# Parts List

## 9. PARTS LIST

SHIPPING ASSEMBLY		
ITEM	DESCRIPTION	PART NO.
1	Monitor Cabinet	F363-00955-00
2	Power cord	VG51-00027-00
3	Link Cable 6	F251 -00028-00
4	Link PCB Assembly	F303-00943-00
5	Manual	F345-00956-00
6	Final Lap 3 Schematics	F345-00944-00
7	FCC Notice	VG46-00031-00
8	Serial Number Label	F246-00032-00
9	Label, FBI	VG44-00150-00
10	Label, Shipping	VG44-00151-00
11	Shipping Box, Main	F260-00033-00
12	Shipping Box, Sear	F260-00034-00
13	Bag Poly, 9 x 12 .002 Kits	VG60-00098-00
14	Bag, 2 Ply 55x45x85	VG60-00152-00

GRAPHICS KIT ASSEMBLY F241-00041-00		
ITEM	DESCRIPTION	PART NO.
1	Decal, Cabinet Right Side	F340-00945-00
2	Decal, Cabinet Left Side	F340-00946-00
3	wrap, Control Panel	F240-00072-00
4	Bezel, Monitor	F340-00947-00
5	Panel, Plastic Display	F340-00948-00
6	Plex, Marquee	F340-00949-00

CONTROL PANEL ASSEMBLYMAPP F205-00046-00		
CONTROL PANEL ASSEMBLY/NAMCO F205-00046-01		
ITEM	DESCRIPTION	PART NO.
1	Metal Control Panel	F210-00073-00
2	ABS Molded Dashboard	F290-00074-00
3	270 Steering Mechanism	DV80-00075-00
4	Speed Shifter Mechanism	DV80-00076-00
5	Keyp Nut	VG20-00077-00
6	Tamper Proof Screw	VG20-00078-00
7	Speaker, 8 Ohm, 10 Watt	VG54-00172-00

MONITOR CABINET ASSEMBLY F202-00025-00		
ITEM	DESCRIPTION	PART NO.
1	Namco PCB Kit	F303-00950-00
2	EMI Cage	S210-00037-00
3	EMI Lid	F210-00153-00
4	EMI Cover Plate	F210-00154-00
5	Nylon Guide 4" 120-400	VG90-00155-00
6	Nylon Guide 7" 120-700	VG90-00156-00
7	Foot Pedal Mechanism	DV80-00951-00
8	Final Lap 2 Monitor Cabinet	F263-00039-00
9	Graphics Kit Assembly	F241-00041-00
10	25" Standard Resolution Color Monitor	VG05-00042-00
11	Plastic Display Panel	F295-00044-00
12	Coin Door Assembly	F263-00045-00
13	Control Panel Assembly	F205-00046-00
14	Caster	VG24-00047-00
15	Harness Assembly	F250-00048-00
16	Service (Utility) Panel Assembly	F305-00952-00
17	Link (Relay) Panel Assembly	F205-00053-00
18	Diamond Plate Cabinet Flooring	F310-00953-00
19	Tamper Proof Key 1/4	VG81-00057-00
20	Tamper Proof Key 1 0/24	VG81-00157-00
21	Fixture Fluorescent, 18" LK-1B	VG57-00058-00
22	Lamp F15T8GW	VG57-00059-00
23	4" Fan 60 CFM	VG55-00060-00
24	4" Fan Guard	VG55-00061-00
25	Speaker	VG54-00062-00
26	Power Supply Assembly	VG88-00080-00
27	Cover, Louvered Vent	VG10-00066-00
26	Bracket, Cabinet floor	F210-00158-00
29	Nut Plate (Levelers)	F210-00159-00
30	Bracket, Top Panel	F210-00160-00
31	Bracket, Acrylic Top	F210-00161-00
32	Door Lock Plate	F210-00162-00
33	Bracket Header Top	F210-00163-00
34	Bracket Header Bottom	F210-00164-00
35	Leg Leveler	VG20-00095-00
36	Lock 2255	VG83-00165-00
37	Coin Gaunter	VG83-00166-00
38	Edge, T 25/32 Green	VG90-00167-00

9. PARTS LIST (cont.)

POWER SUPPLY ASSEMBLY VG88-00080-00		
ITEM	DESCRIPTION	PART NO.
1	Power Supply XT-1 50	VG88-00954-00

LINK (RELAY) PANEL ASSEMBLY F205-00053-00		
ITEM	DESCRIPTION	PART NO.
1	Link (Relay) Panel Bracket	F210-00099-00
2	Link (Relay) PCB Assembly	F203-00100-00
3	Fastner	F220-00101-00

COIN DOOR ASSEMBLY VG83-00045-00		
ITEM	DESCRIPTION	PART NO.
1	Double Frame Mini Door	VG83-00045-00
2	Coin Harness	VG83-00087-00
3	Cash Box	VG83-00088-00
4	USA Coinage Decal 2/25	VG83-00089-00
5	Coin Counter	VG83-00090-00

HARNESS ASSEMBLY F250-00048-00		
ITEM	DESCRIPTION	PART NO.
1	Main Harness Assembly	F250-00178-00
2	Wire Harness, IBM ISO A/C	F250-00179-00
3	A.C. Power Harness	F250-00180-00
4	IBM/ISO	F250-00181-00
5	Harness #6 Spade EXT	F250-00182-00
6	EXT, AC/Brake	F250-00183-00
7	Car Color Select	F250-00184-00
8	TSA Harness & Bracket	F250-00185-00
9	AC SW	F250-00186-00
10	Pedals, 26" GRD>	F250-00187-00
11	Driver 40" GND Coin	F250-00188-00
12	Monitor 45" GND	F250-00189-00
13	Panel, Cont 45" GRD	F250-00190-00
14	Coin Door	F250-00191-00
15	EXT Coin Door	F250-00192-00
16	DC Power	F250-00193-00
17	Harness Link	F250-00194-00
18	Pigtail Lamp	F250-00195-00

SERVICE (UTILITY) PANEL ASSEMBLY F205-00052-00		
ITEM	DESCRIPTION	PART NO.
1	Service (Utility) Panel	VG10-00102-00
2	Volume Potentiometer	VG75-00103-00
3	Volume Knob	VG64-00104-00
4	Test Slide Switch	VG53-00105-00
5	Service Harness Assembly	VG50-00106-00
6	Fastner, Self Thread Screw	VG20-00107-00



# Wiring Diagrams

REFER TO THE BELOW CONNECTORS FOR CAR COLOURS.



COLOR CONNECTOR NO.  
 1. YELLOW  
 2. RED  
 3. BLU./WH. TE.  
 4. L. BLUE

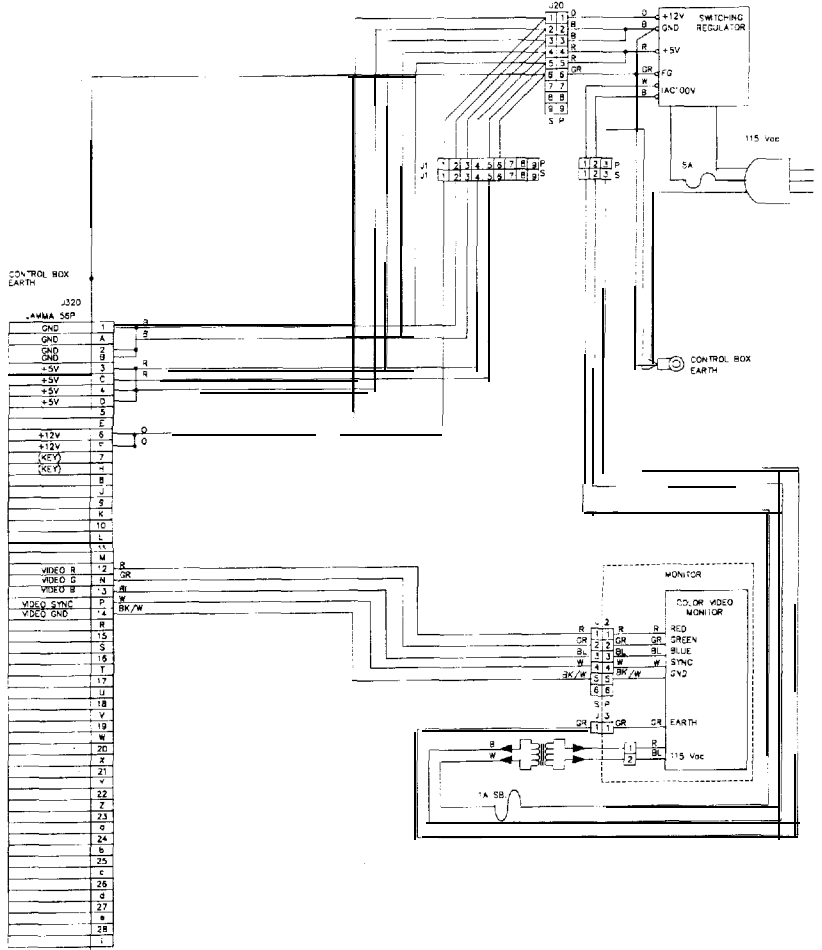

A C & D C POWER SOURCES

FINAL LAP" 3 UPRIGHT WIRING DIAGRAM

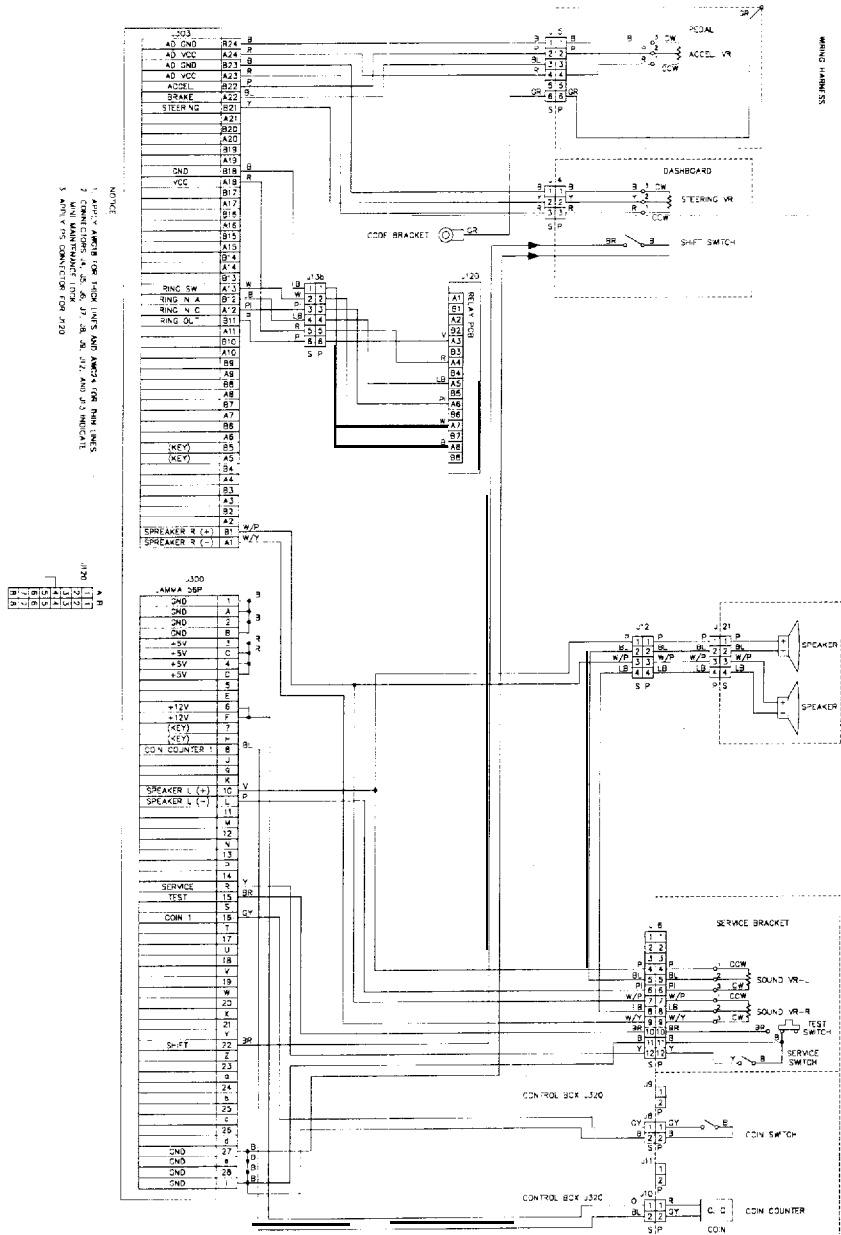

FINAL LAP™ 3 UPRIGHT WIRING DIAGRAM

NOTES: